



 **kauradent**

GERMAN STEEL

666 691 426 

kauradent@gmail.com 

CE

**Extracting Forceps (English pattern)/  
Forceps de Extraccion (Forma ingles)**



**101**  
**Fig. 1**  
Upper Centrals & Canines  
Incisivos y caninos superiores

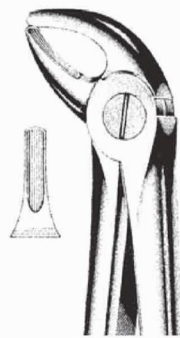

**104**  
**Fig. 4**  
Lower Centrals & Canines  
Incisivos y caninos inferiores

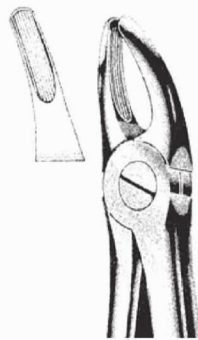

**105**  
**Fig. 7**  
Upper Premolars  
Premolares Superiores



**106**  
**Fig. 8**  
Lower Premolar  
Premolares Inferiores



**107**  
**Fig. 13**  
Lower Premolar  
Premolares Inferiores

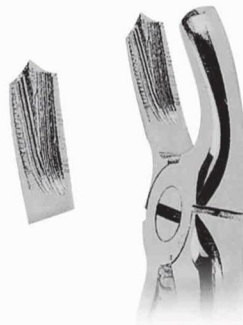

**108**  
**Fig. 17**  
Right Upper Molars  
Molares Superiores Derechos

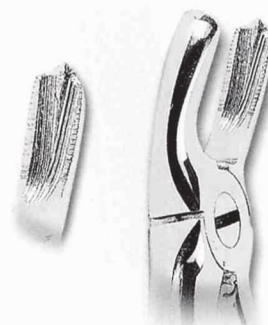

**109**  
**Fig. 18**  
Left Upper Molars  
Molares Superiores Izquierdos



**113**  
**Fig. 21**  
Lower Molars  
Molares Inferiores



**114**  
**Fig. 22**  
Lower Molars  
Molares Inferiores



**122**  
**Fig. 33**  
Lower Roots  
Raices Inferiores



**123**  
**Fig. 33A**  
Lower Roots  
Raices Inferiores



**130**  
**Fig. 51A**  
Upper Roots Narrow Beak  
Raices Superiores

**Extracting Forceps (English pattern)/  
Forceps de Extraccion (Forma ingles)**

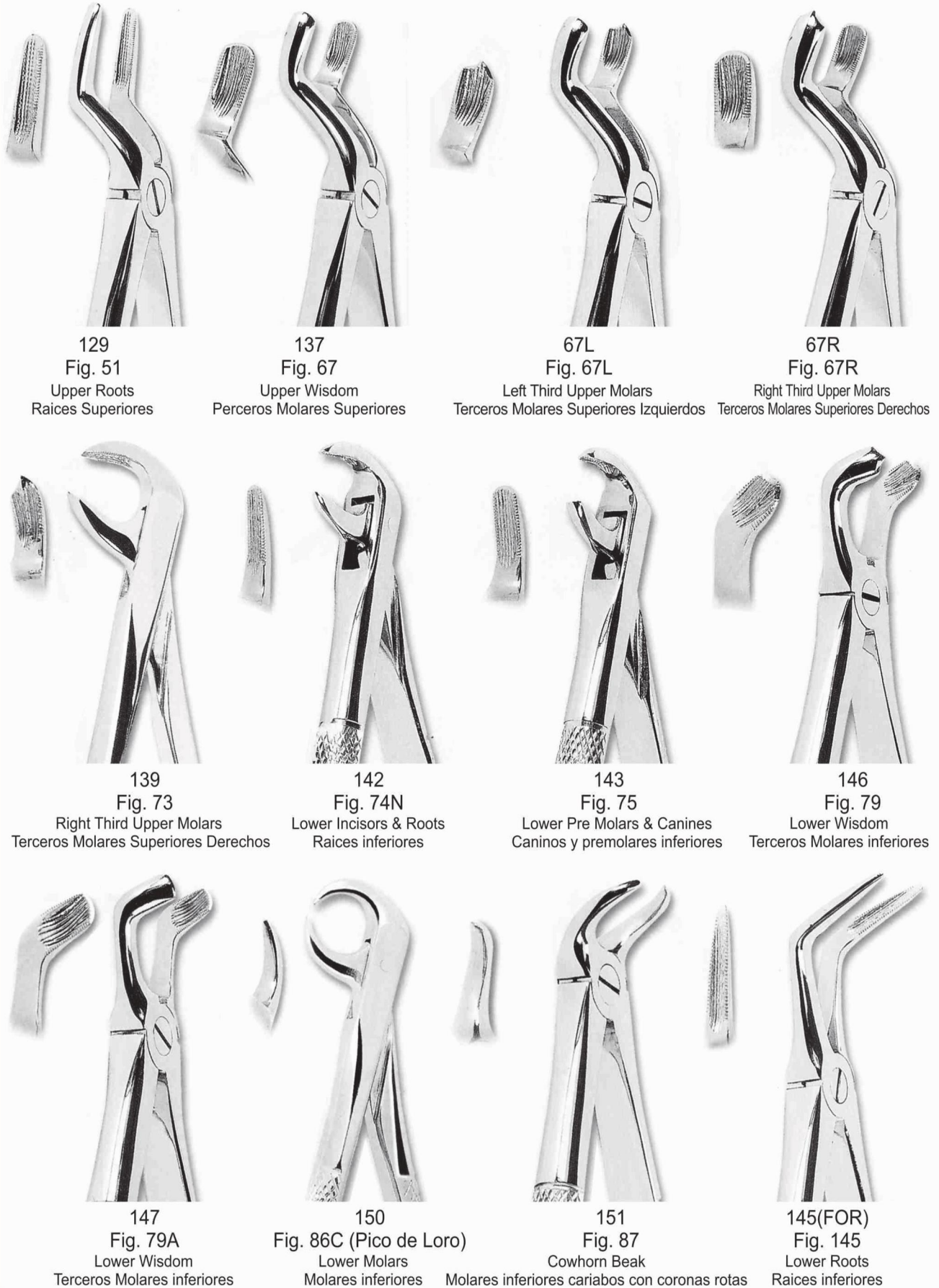



**Extracting Forceps (English pattern) /  
Forceps de Extraccion (Forma ingles)**

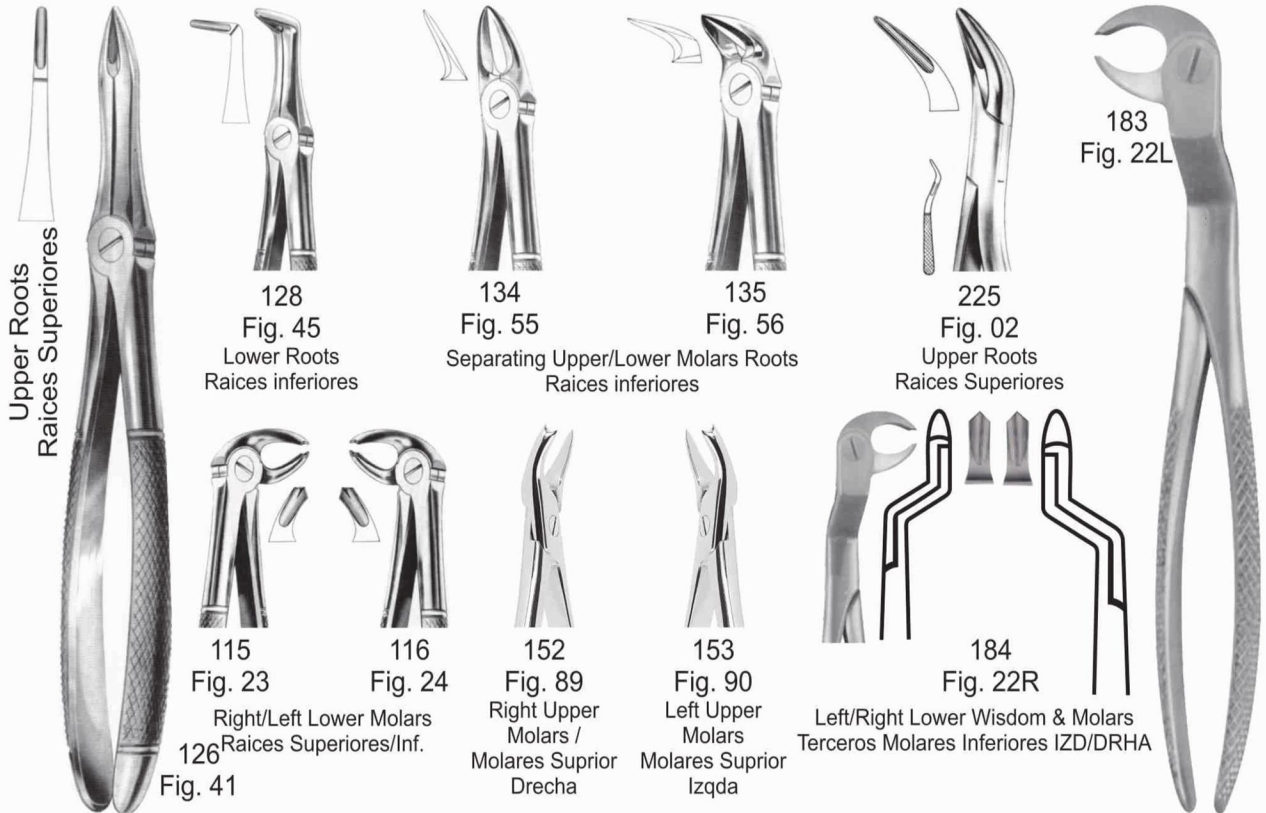

**Extracting Forceps (American Pattern) /  
Forceps de Extraccion (Forma Americana)**

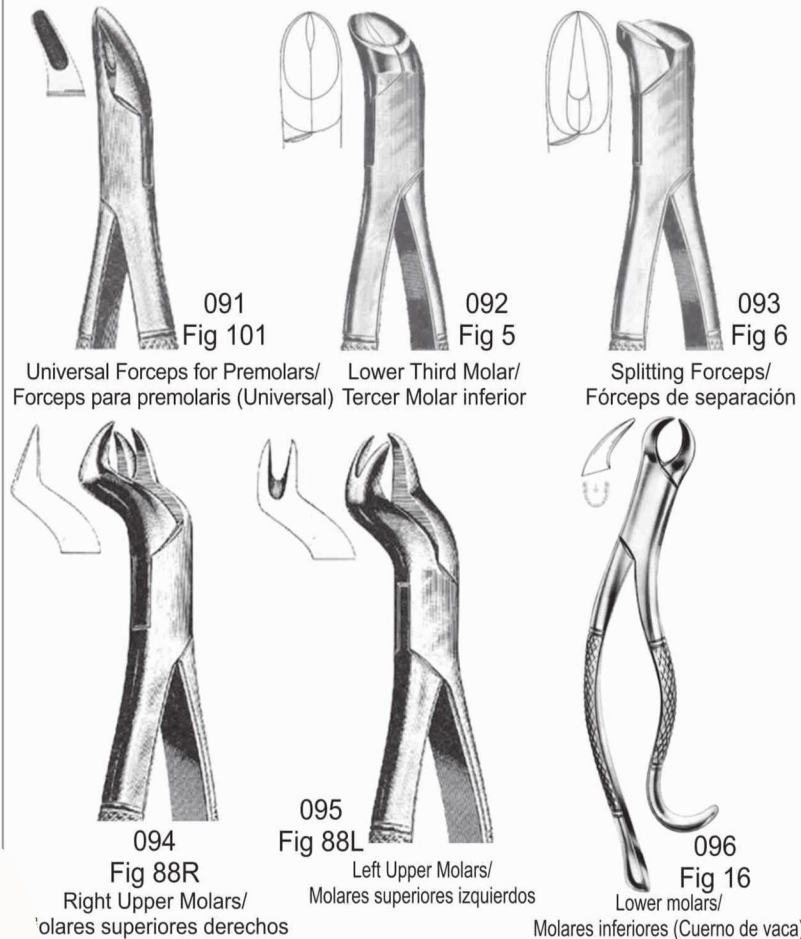

Kit of forceps 11pcs (Adult) /  
Juego de forceps 11unidad (Adulto)  
Fig. 01, 07, 13, 17, 18, 22, 33, 51A, 67A, 79, 86C  
(English Pattern / Forma ingles)



**Extracting Forceps (Children - English pattern) /  
 Forceps de Extraccion (Niños - Forma ingles)**



**189**  
**Fig. 137**  
 Upper Incisors & Canines  
 Incisivos Superiores



**186**  
**Fig. 05**  
 Lower Incisors  
 Incisivos inferiores



**187**  
**Fig. 06**  
 Lower Molars  
 Molares inferiores



**188**  
**Fig. 07**  
 Lower Root  
 Raices inferiores



**185**  
**Fig. 03**  
 Upper Molars  
 Molares Superiores



**190**  
**Fig. 139**  
 Upper Premolars  
 Premolares Superiores



**191**  
**Fig. 51S**  
 Upper Roots  
 Raices Superiores



**1545**  
 Kit of Forceps 7 pcs Children (Complete) /  
 Kit de fórceps 7 piezas Niños (Completo)



**228**  
 Root Fragments (Str)



**229**  
 Root Fragments (Cuvd)



## Bone Rongeurs Pinza Gubias



235  
Ruskin-Mini  
15.5 cm



230  
Blumenthal 30°  
15 cm



231  
Blumenthal 45°  
14.5 cm



232  
Blumenthal 90°  
14 cm

### Suction Tubes / Canulas de aspiracion quirurgica



1416  
3.0 mm

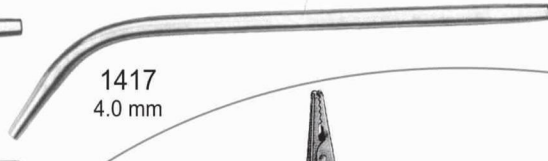

1417  
4.0 mm



1418  
5.0 mm



1051  
Napkin Holder  
with Plastic Band



1052  
Napkin Holder  
with Metal Chain



011  
Auto Matrices  
Kit Complete /  
Kit Completo  
14.6cm (Inox)



012  
Handle Auto Matrices  
Only Handle / Solo Mango  
11cm (Inox)  
(Reposicion)



013  
Point Auto Matrices  
Only point / Solo punta  
4.5cm (Inox)  
(Reposicion)



437-R  
Mosquito (Str)  
12 cm



437-C  
Mosquito (Cuvd)  
12 cm

**Retractors**  
**Retradores**



547  
Langenbeck  
21 cm  
40x10mm

RETRACTOR LABIAL



21 cm

1633

KIT DE OBTENCION DE INJERTO DE TIBIA O CADERA



22 cm

1645

RETRACTORES DE APICECTOMIA, DENTADAS

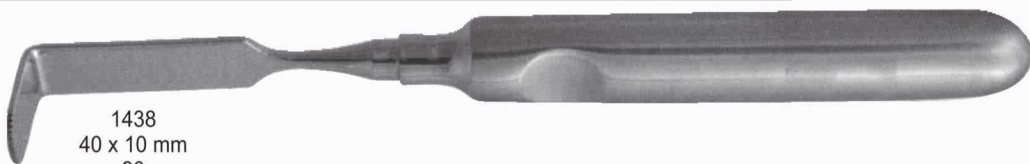

1438  
40 x 10 mm  
90

RETRACTORES DE APICECTOMIA, DENTADAS

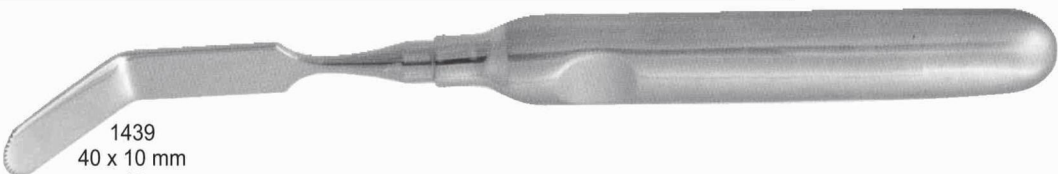

1439  
40 x 10 mm  
45



# Root Elevators

## Botadors

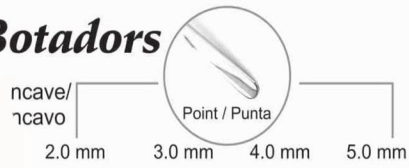

243 Bein  
244 Bein  
245 Bein

242 Bein



321 Bein  
322 Bein

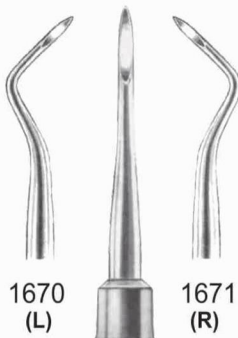

1670 (L)  
1671 (R)



325 Heidbrink

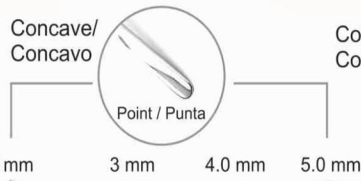

314 Bein  
315 Bein  
320 Bein

313 Bein

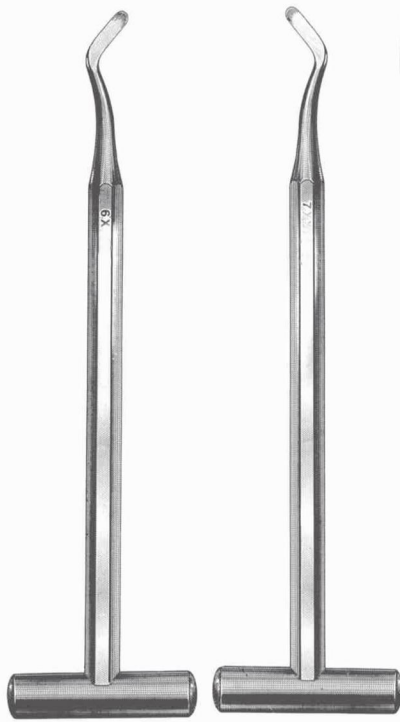

1800 (Left) Pott

1800 (Right) Pott

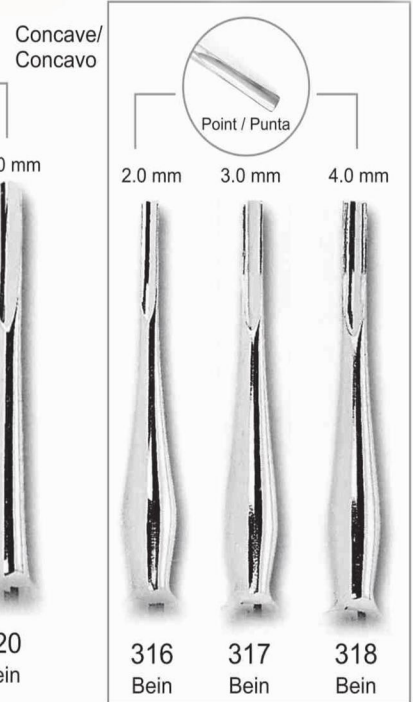

316 Bein  
317 Bein  
318 Bein

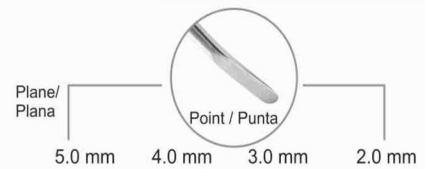

249 Bein  
248 Bein  
247 Bein

246 Bein



# Root Elevators Botadores



264  
Seldin  
Fig 23

265  
Seldin  
Fig 24

282  
Fig. 44  
Cryer

283  
Fig. 45  
Cryer



579



595-5



578



Walter F. Barry



327  
Fig. 320



328  
Fig. 321



1500  
Fig. 370



1501  
Fig. 371

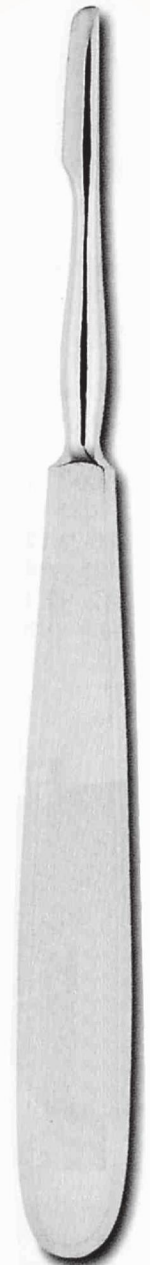

577  
Chompret  
15 cm

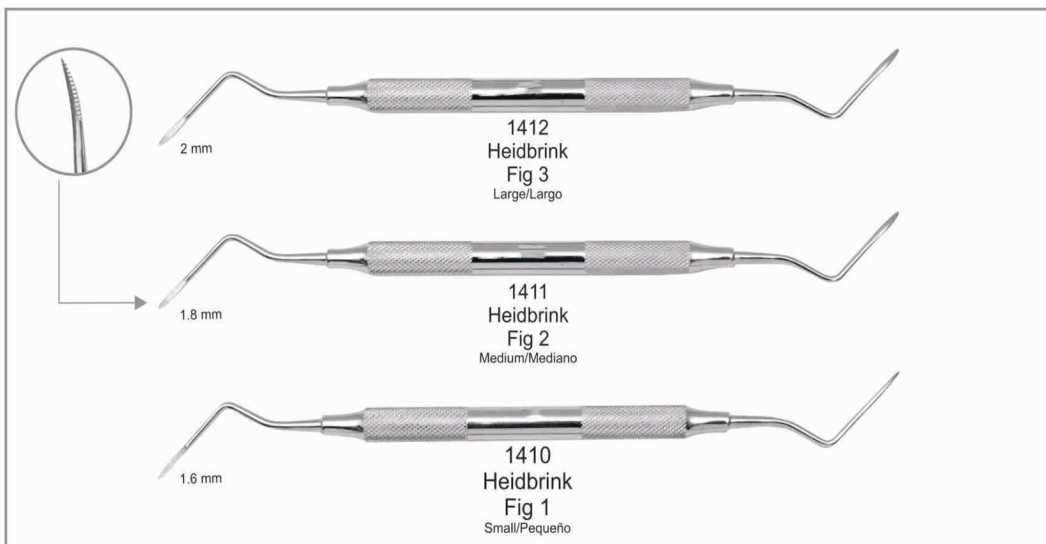

### Luxator/luxador

**New**

1569	2mm STR		
1570	3mm STR		Recta
1571	3mm Curved		Curva
1572	5mm STR		Recta
1573	5mm Curved		Curva

Plane Point  
Punta Plana

### Luxator/luxador

1700	2mm S		Recta
1701	3mm C		Curva
1702	3mm S		Recta
1703	3mm CA		Curva Angulo
1704	3mm IC		Up Curved
1705	5mm C		Curva
1706	5mm S		Recta
1707	3mm DE		Recta
1708	5mm DE		Recta

### Luxator Metal Handle /Luxador Con Mango de Metal

**New**

1569MT	2mm STR		Recta
1570MT	3mm STR		Recta
1571MT	3mm Curved		Curva
1572MT	5mm STR		Recta
1573MT	5mm Curved		Curva

Plane Point  
Punta Plana

1700MT	2mm S		Recta
1701MT	3mm C		Curva
1702MT	3mm S		Recta
1703MT	3mm CA		Curva Angulo
1704MT	3mm IC		Up Curved
1705MT	5mm C		Curva
1706MT	5mm S		Recta
1707MT	3mm DE		Recta
1708MT	5mm DE		Recta





1073  
Crown Spreaders  
(Universal)



1672  
Crown Remover  
Beerendonk  
mm 130



1078  
Crown Remover



A B C  
3 Point Complete Set



A B C  
Only 3 point set/  
Solo juego de puntas  
090



2003  
Crown Remover  
15cm



1076  
Crown Remover



2005(L)  
Crown Remover  
(IZQDA)



2005(R)  
Crown Remover  
(DRHA)



2004  
Crown Remover  
15cm

SEPARADOR LABIAL

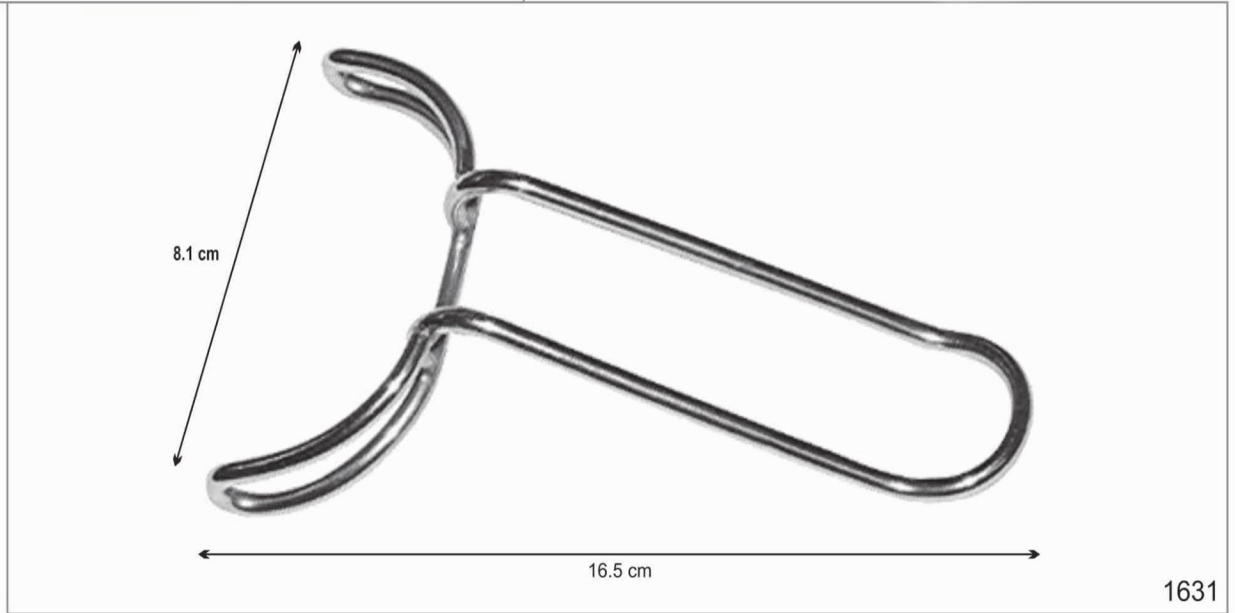

RETRACTOR PARA LABIAL



**Mouth Gauge**  
**Abre Bocas**

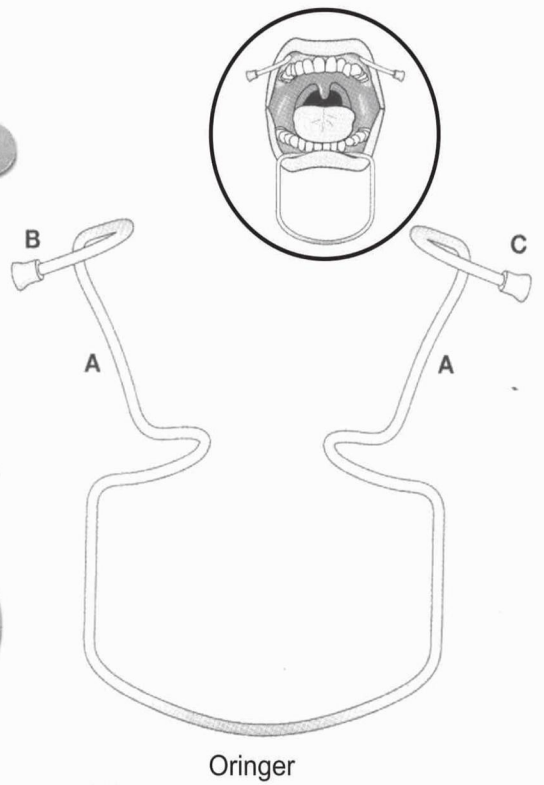

- 1403 Small - Pequeño 40 x 105 mm
- 1404 Medium - Mediano 50 x 110 mm
- 1405 Large - Largo 60 x 115 mm

# Needle Holder Porta Aguja

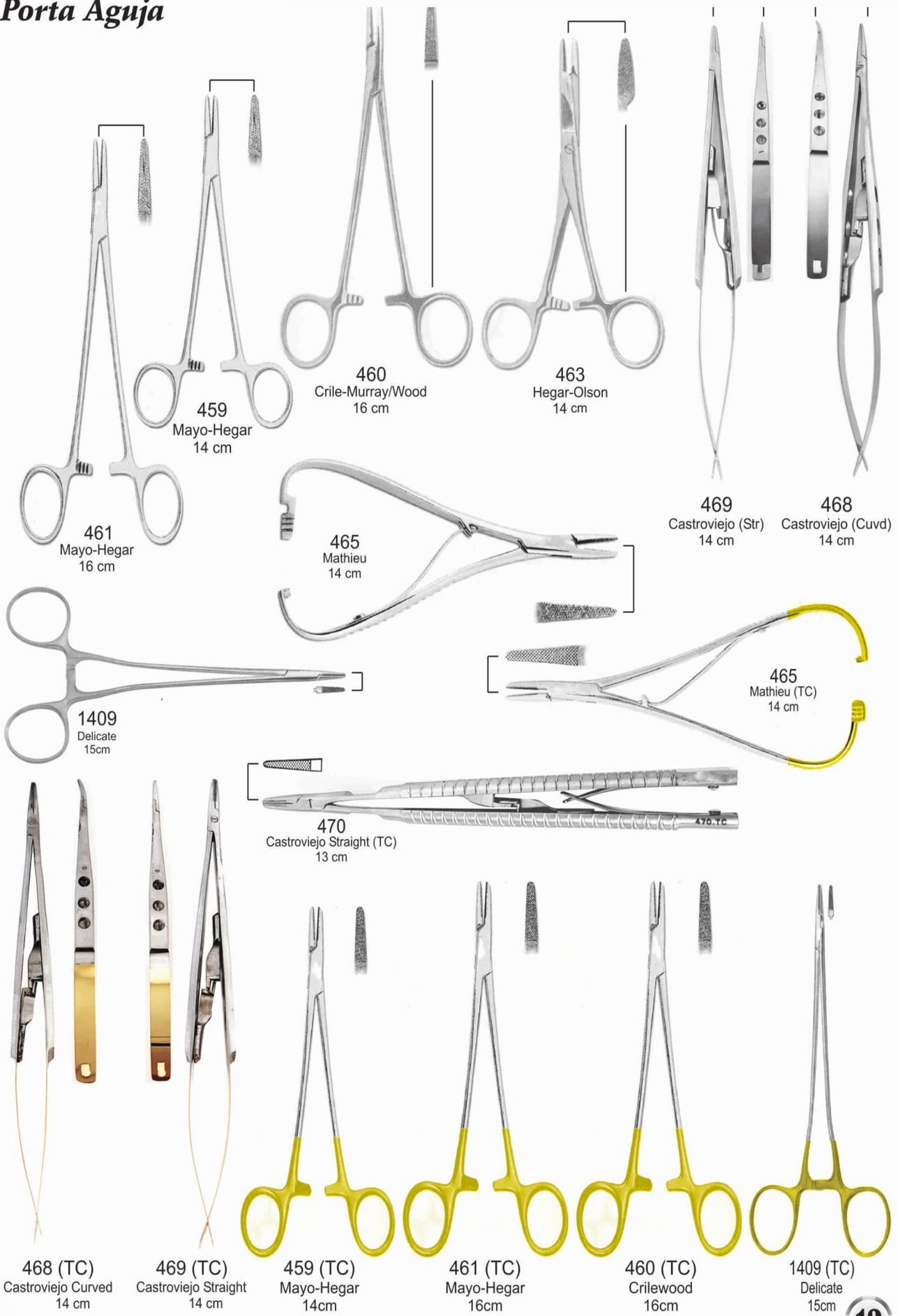

461  
Mayo-Hegar  
16 cm

459  
Mayo-Hegar  
14 cm

460  
Crile-Murray/Wood  
16 cm

463  
Hegar-Olson  
14 cm

469  
Castroviejo (Str)  
14 cm

468  
Castroviejo (Cuvd)  
14 cm

465  
Mathieu  
14 cm

1409  
Delicate  
15cm

465  
Mathieu (TC)  
14 cm

470  
Castroviejo Straight (TC)  
13 cm

468 (TC)  
Castroviejo Curved  
14 cm

469 (TC)  
Castroviejo Straight  
14 cm

459 (TC)  
Mayo-Hegar  
14cm

461 (TC)  
Mayo-Hegar  
16cm

460 (TC)  
Crilewood  
16cm

1409 (TC)  
Delicate  
15cm



# Dental Syringes Jeringas Dentales



1037  
1.8 ml  
Ineraligmentary Syringe

Needle Screw European.  
Aguja Rosca Europeo.



1686  
Ineraligmentary Syringe Str (inox)

MI 1.8  
mm 110



MI 1.8  
mm 110

**New**  
New system with Button  
Nuevo sistema con Boton

1408  
Ineraligmentary Syringe Cvd (inox)



MI 1.8  
mm 110

**New**  
New system with Button  
Nuevo sistema con Boton

1407  
Ineraligmentary Syringe Str (inox)

Special Aspirating Point/  
Punta de aspiración especial



**New**



2118  
Dental Cartridge  
Syringe (Classic)



1040  
Aspirated Syringe



1039  
Aspirated Syringe



1041  
Cartridge Syringe (Folding)  
(ARTICULADA)



**New**



Folding/  
Articulada



New Model with  
3 aspirating hooks,  
utilizable only  
on hollow small  
rubber caps.

Nuevo modelo  
con 3 ganchos  
utilizo solo  
con goma hueca.

Close/  
Cerrar

Open/  
Abrir

1414  
Aspirated Syringe  
1.8 mm  
(ARTICULADA)



**New**

1415  
Aspirated Syringe (Auto)  
1.8 mm

**Scissors**  
**Tijeras**

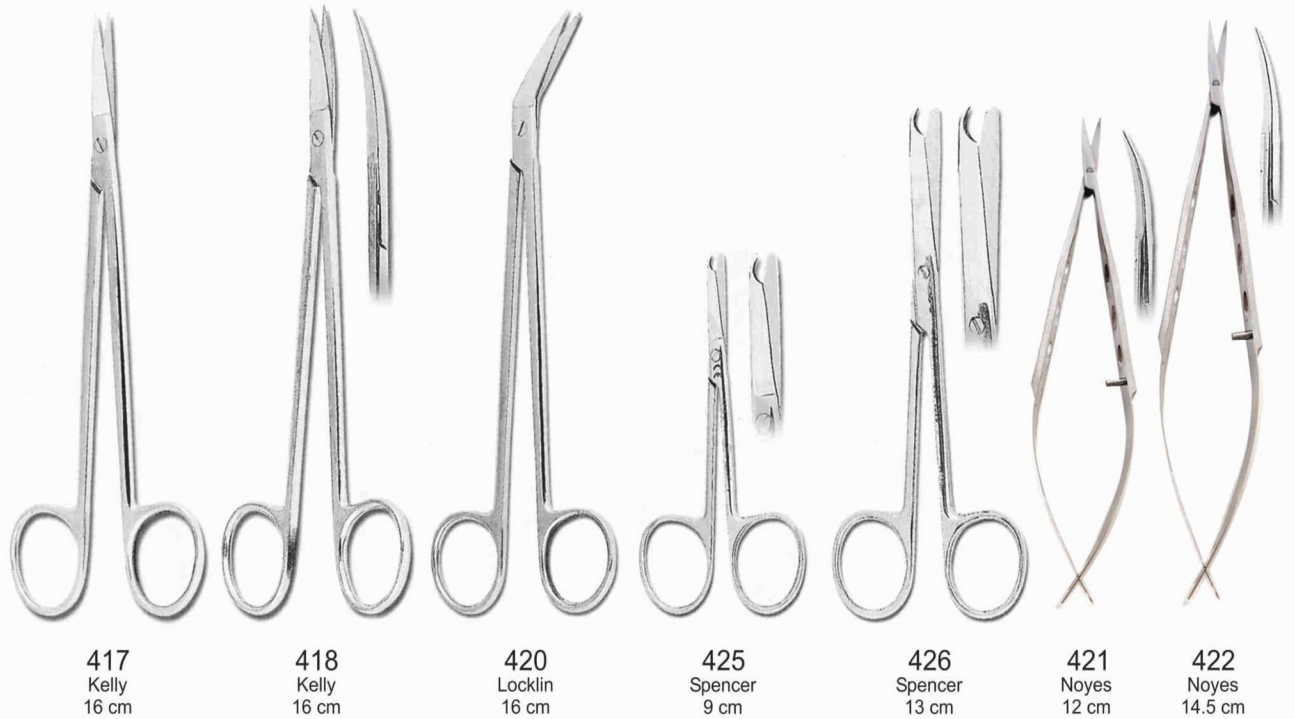
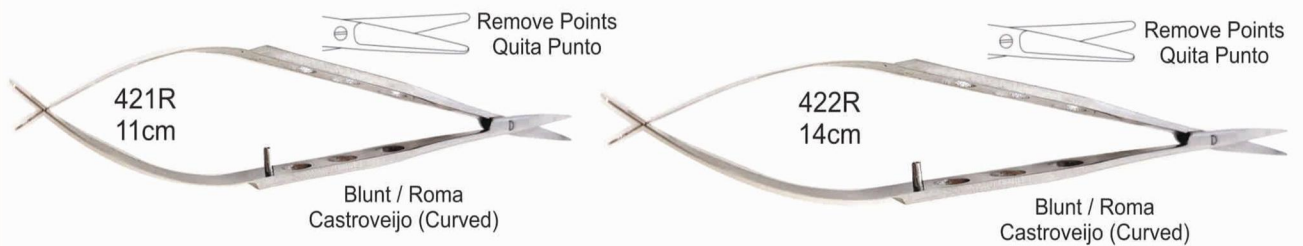
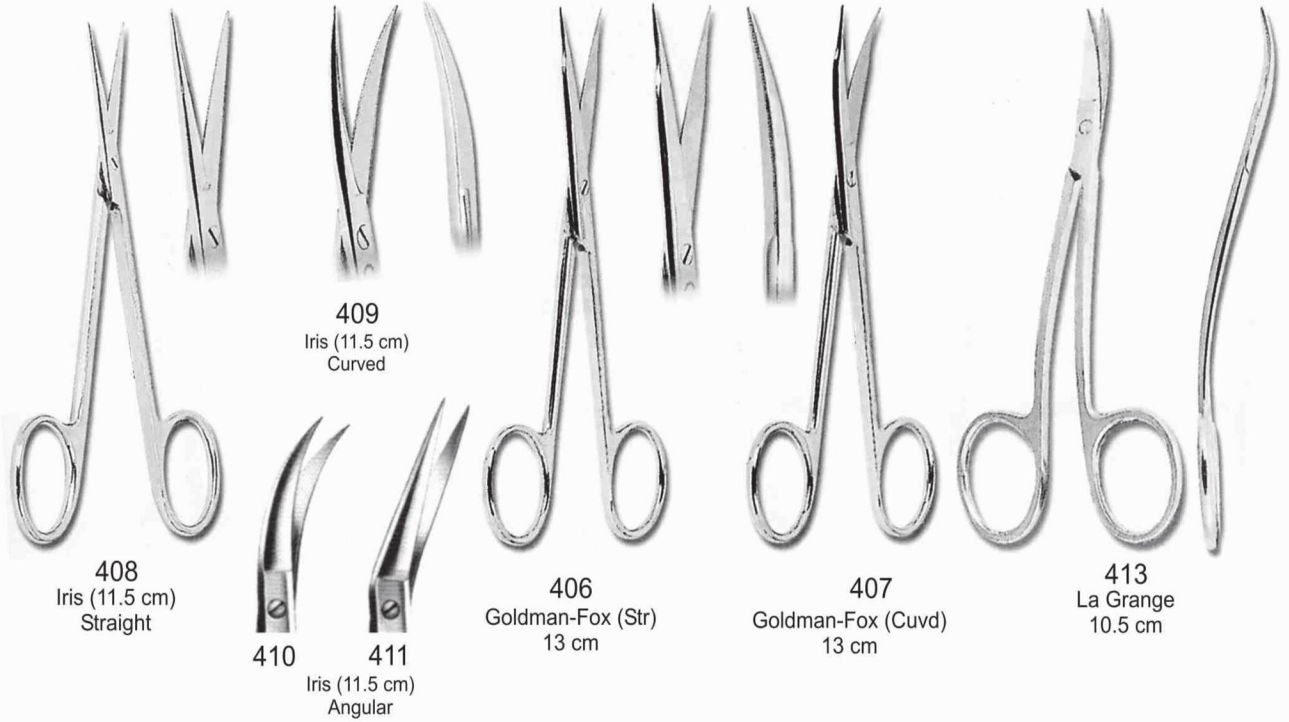

**Tweezers "Cotton & Tissue"**  
**Pinza Para Algodon Y Cirugia**

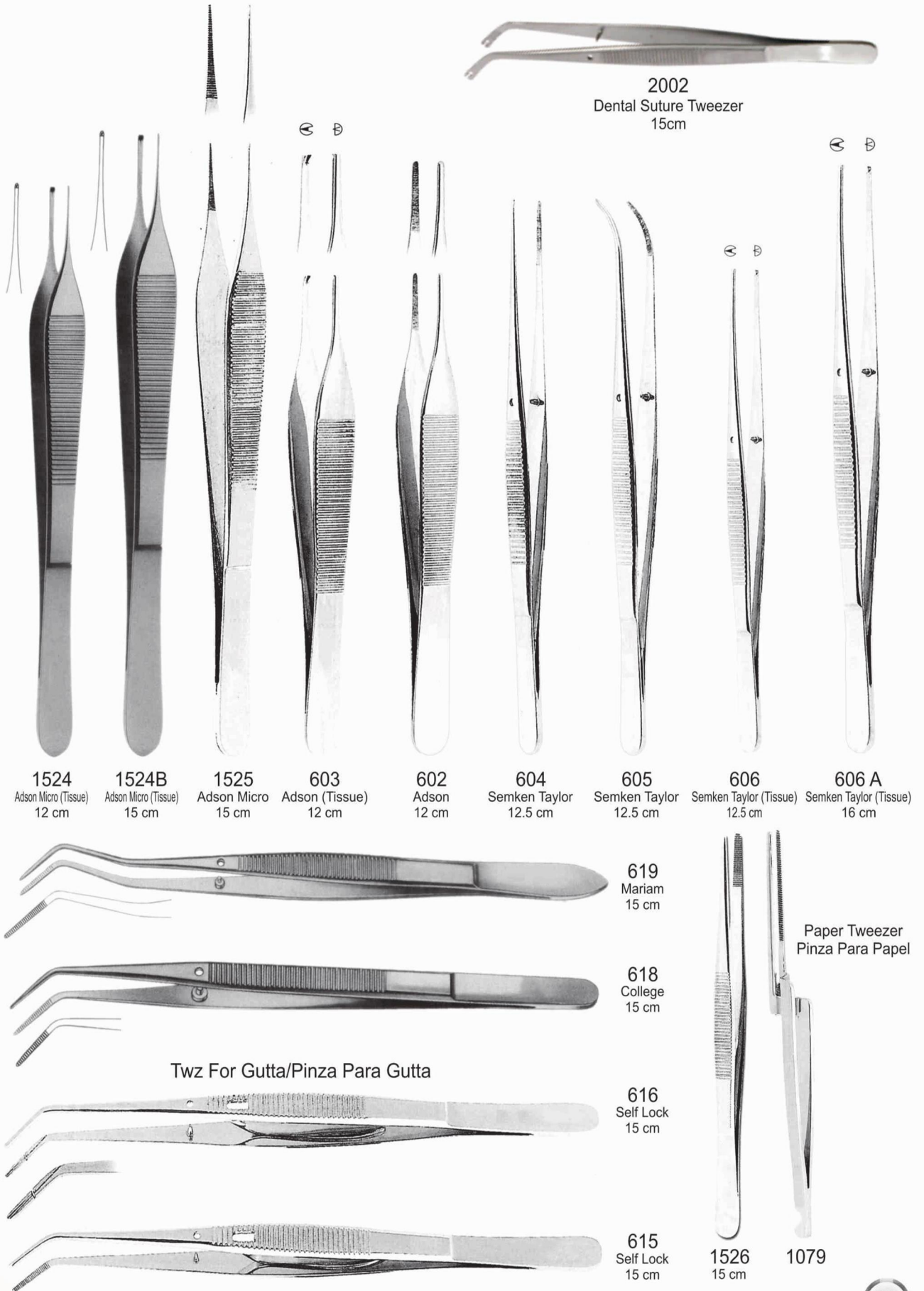



# Elevators Elevadors

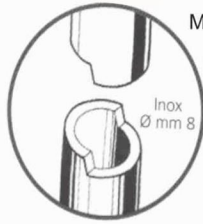

Inox hollow  
light handle.  
Mango en acero  
inoxidable  
hueco ligero.



859  
Molt

9A  
Allen

MV2  
Hourigan/  
Busher

863  
Prichard

864  
Freer

865  
Freer

862  
Mead

3 mm  
1413  
Molt

5.0 mm  
565  
Williger  
14 cm

3.0 mm  
557  
Freer

## Chisels / Cinceles

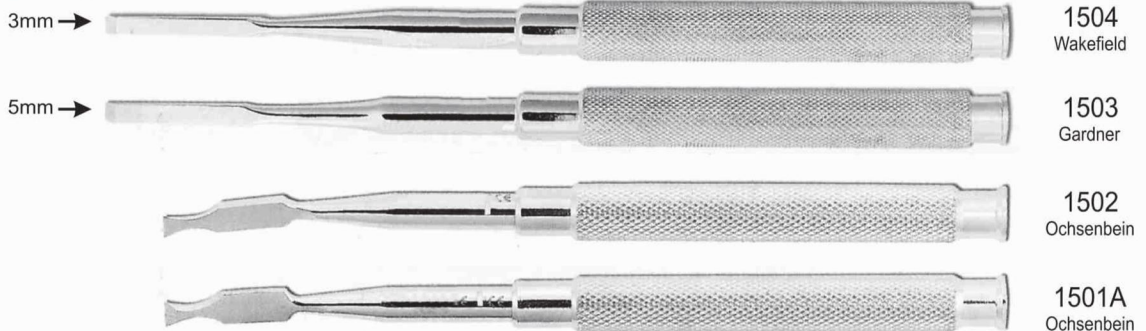

1504  
Wakefield

1503  
Gardner

1502  
Ochsenbein

1501A  
Ochsenbein

## Amalgam Carriers Porta Amalgama

## Scalpel Handles Mango de Bisturi



Bone Files  
Lima Para Hueso



## Mirror Handles | Mango Espejos

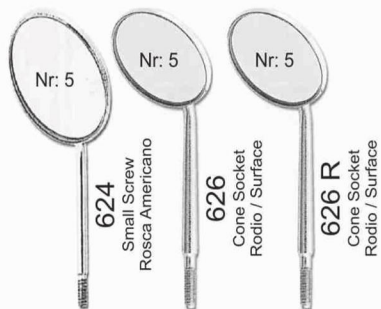

2113 → Surface / Rodio CS  
2115 → Surface / Rodio Rosca Americano



**Explorers (Single)**  
**Sondas (Sencilla)**

**Explorers (Double)**  
**Sondas (Doble)**

**Explorers (Endodontic)**  
**Sondas (Calibradas)**

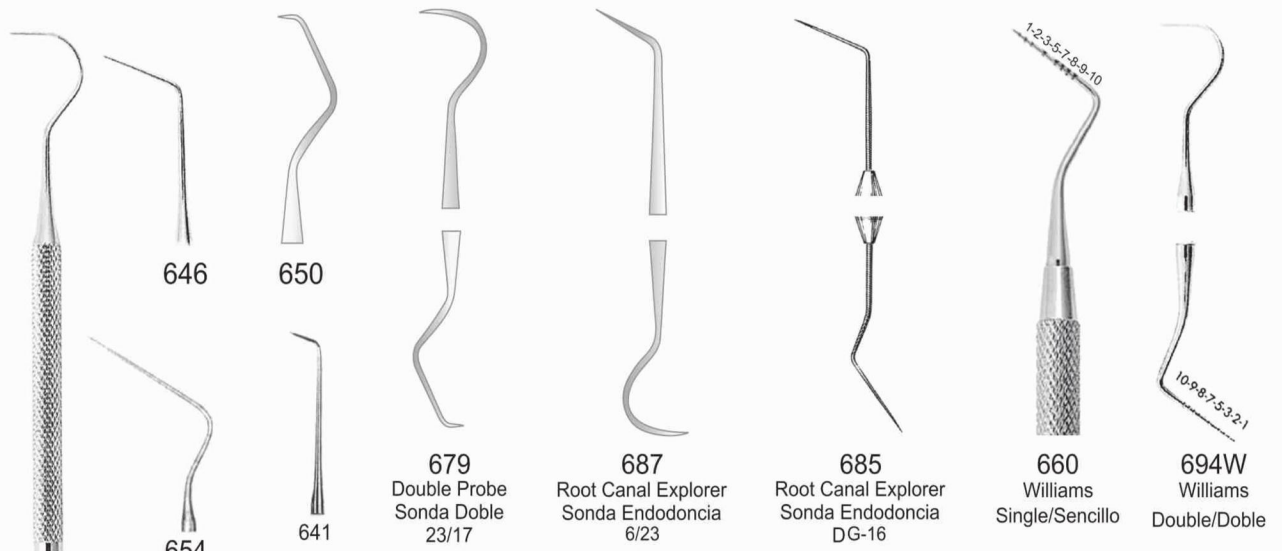

**Periodontal Probes**  
**Sondas Parodontales**

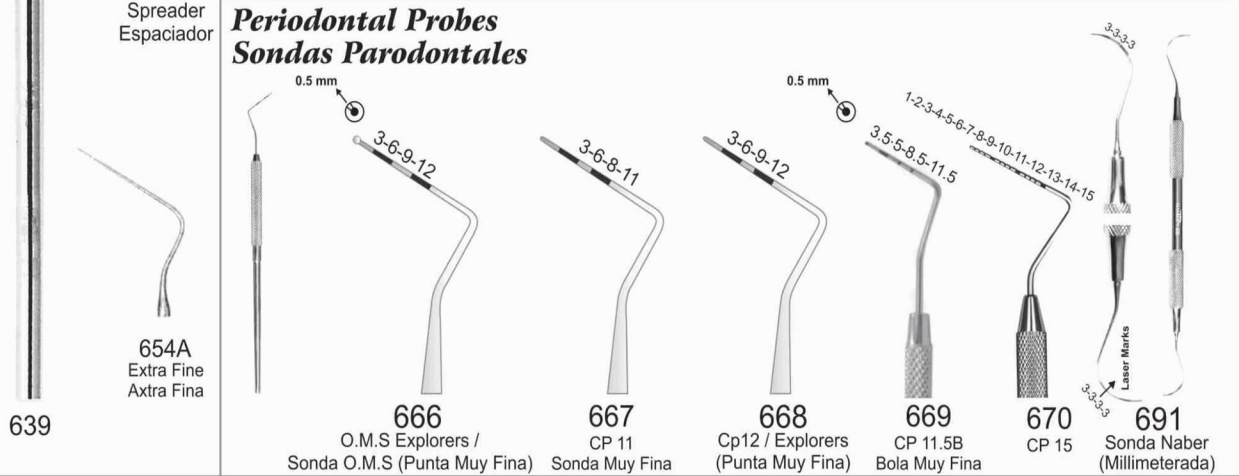

**Filling Instruments / Bruñidores y Atacadores**

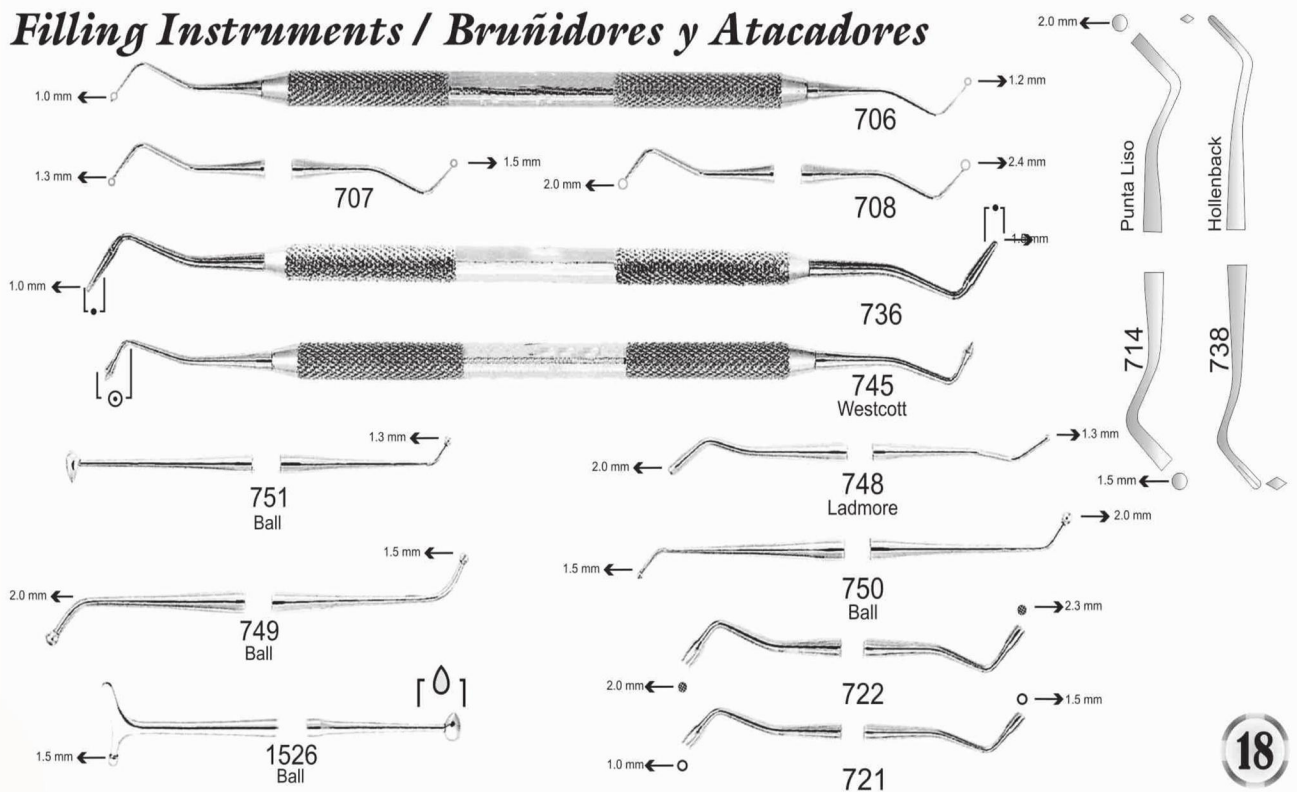



## Bone Currettes / Cucharillas Alveolares

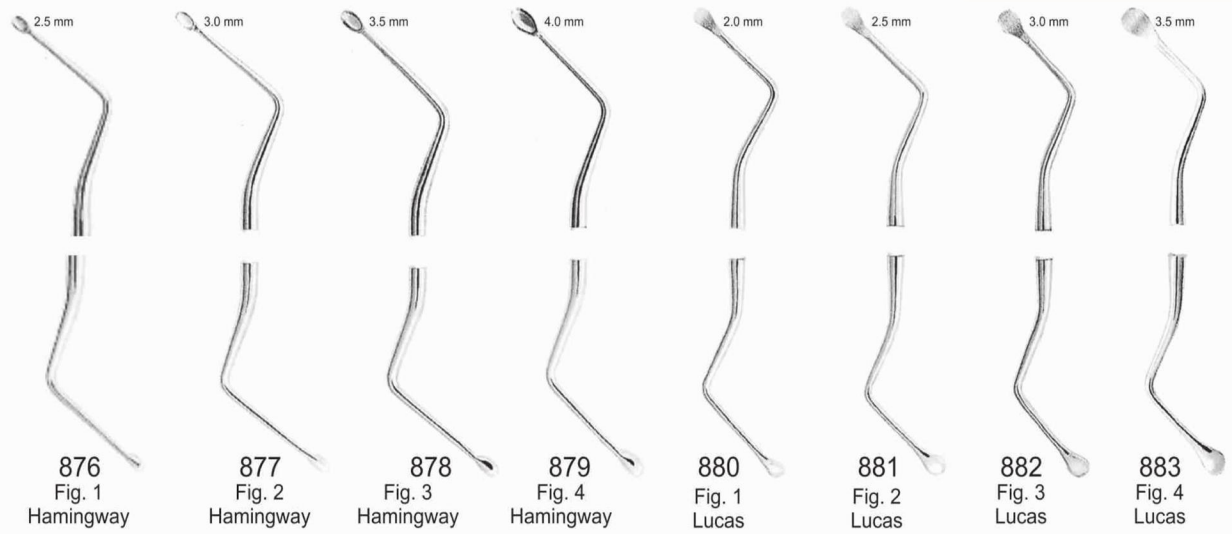

## Bone Currettes / Curtas, Cinceles y Obturaciones Plsticas

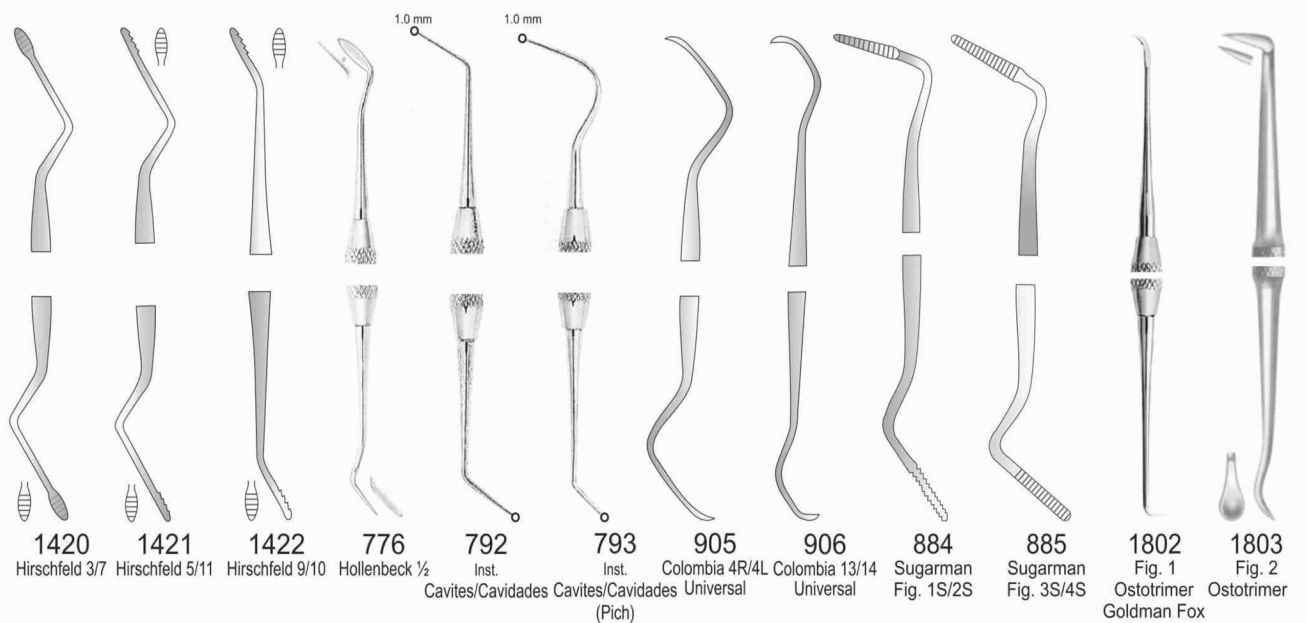
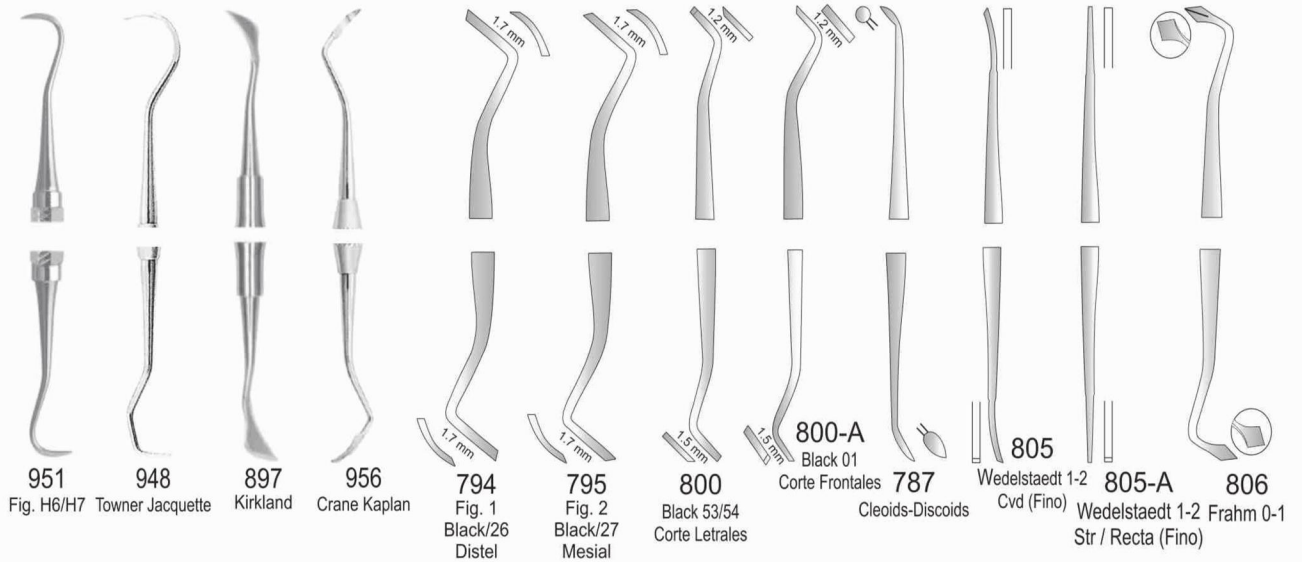

# Excavators

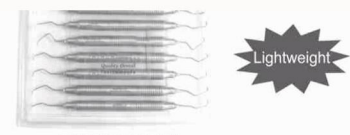
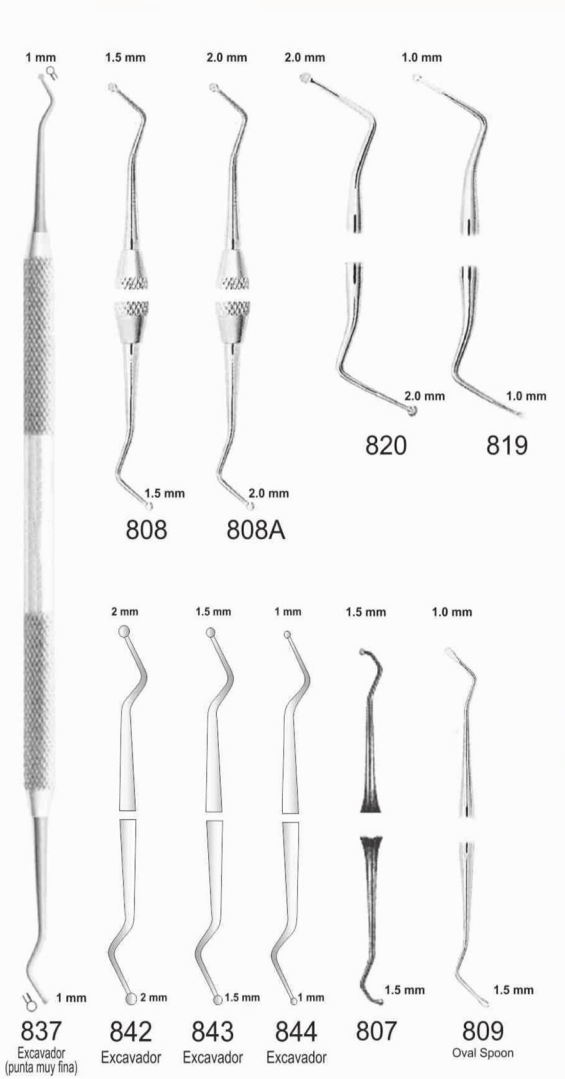

025-280-T  
Titanium Coted Gracy  
Hallow Handle 9.5 mm

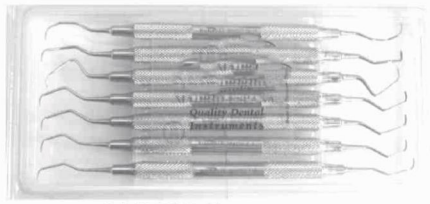
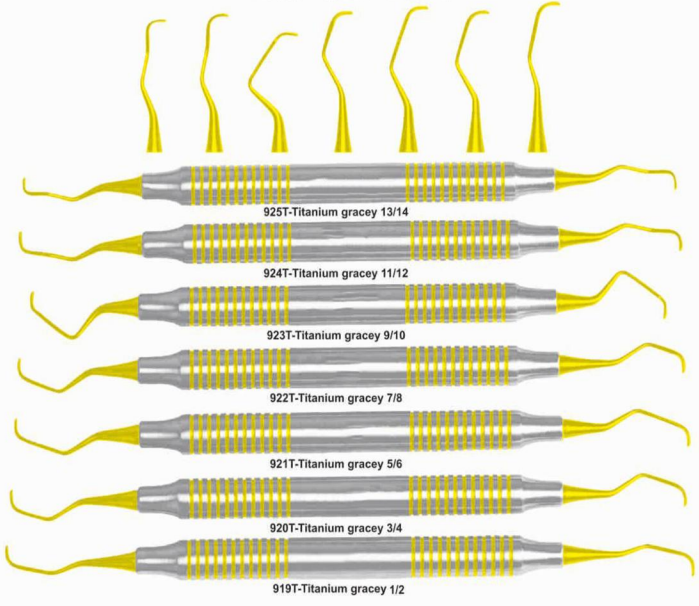

025-280-S (Handle 8mm)

**Instruments for Threads**  
**Instrumentos para Hilo**

New

Dentadas

1401, 1402

**Explorer Kit**

2000

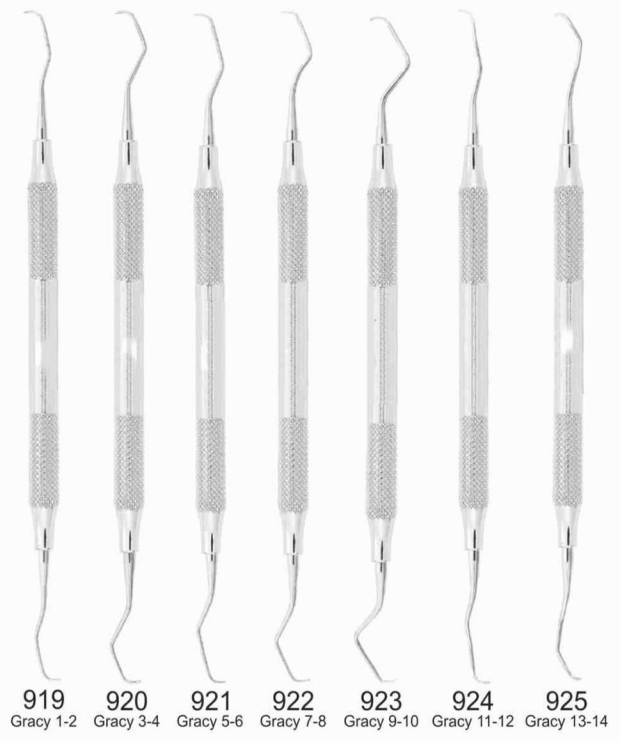

**Cement Spatulas**  
**Espatulas Para Cemento**

**Espatulas Para Composite**

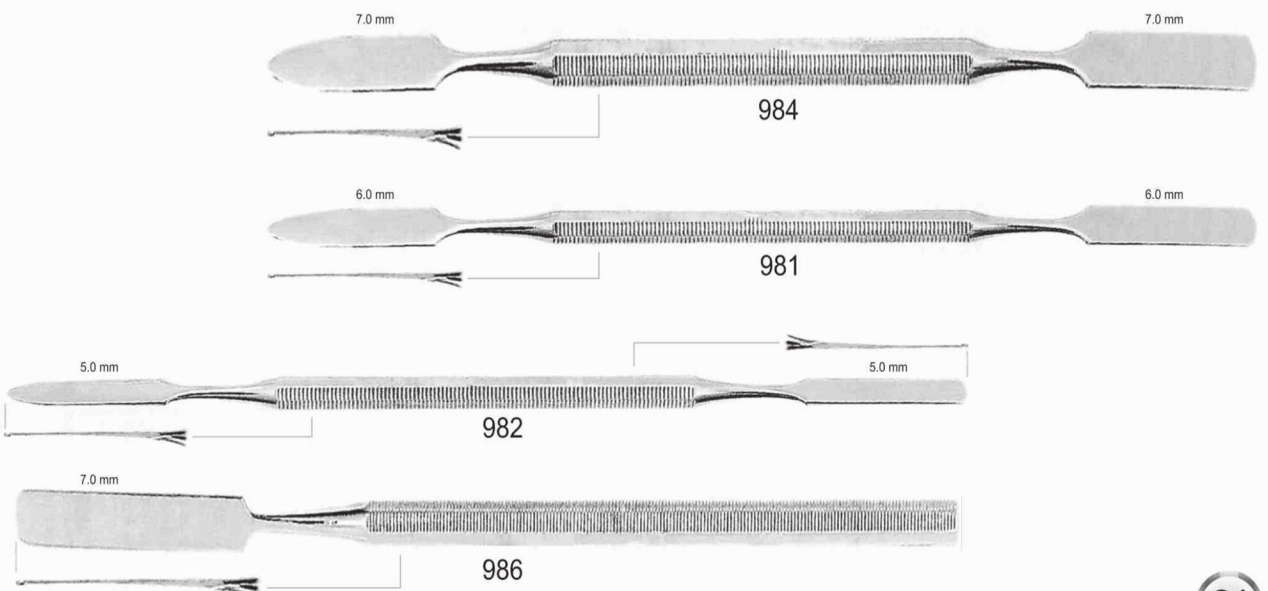
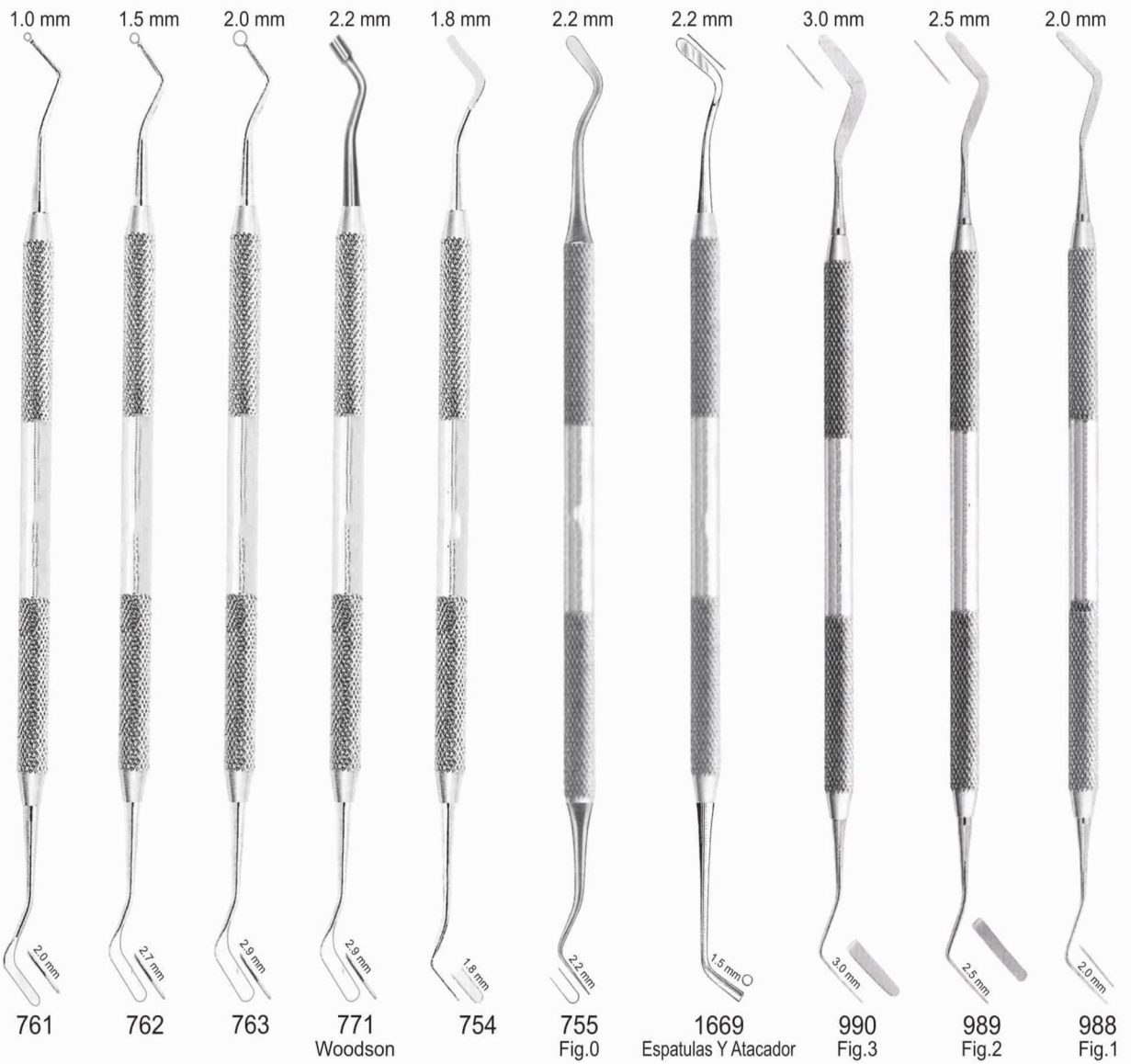



## Espatulas Para Composite

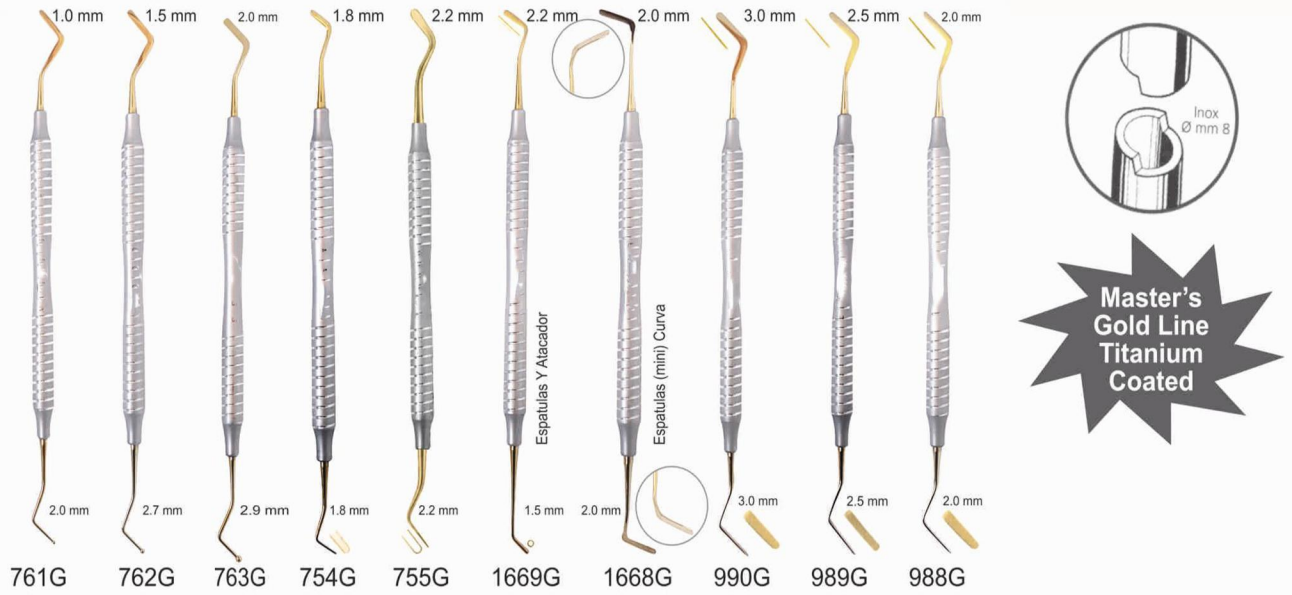

## Filling Instruments / Bruñidores y Atacadores

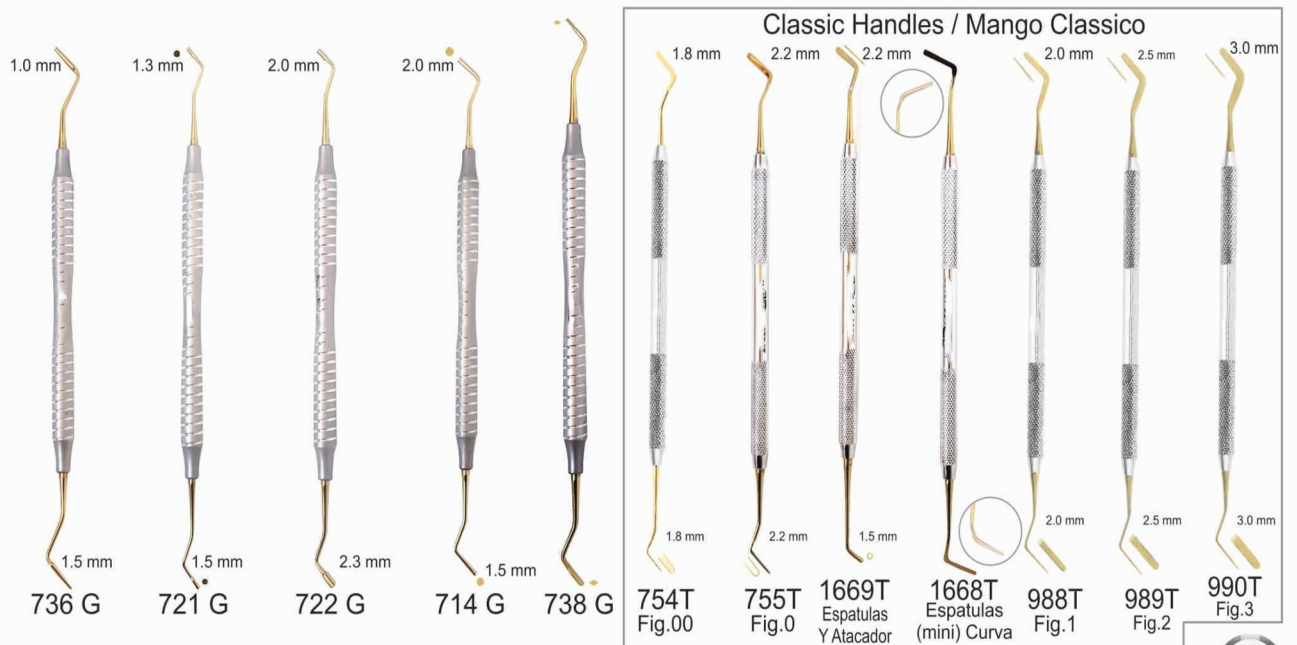
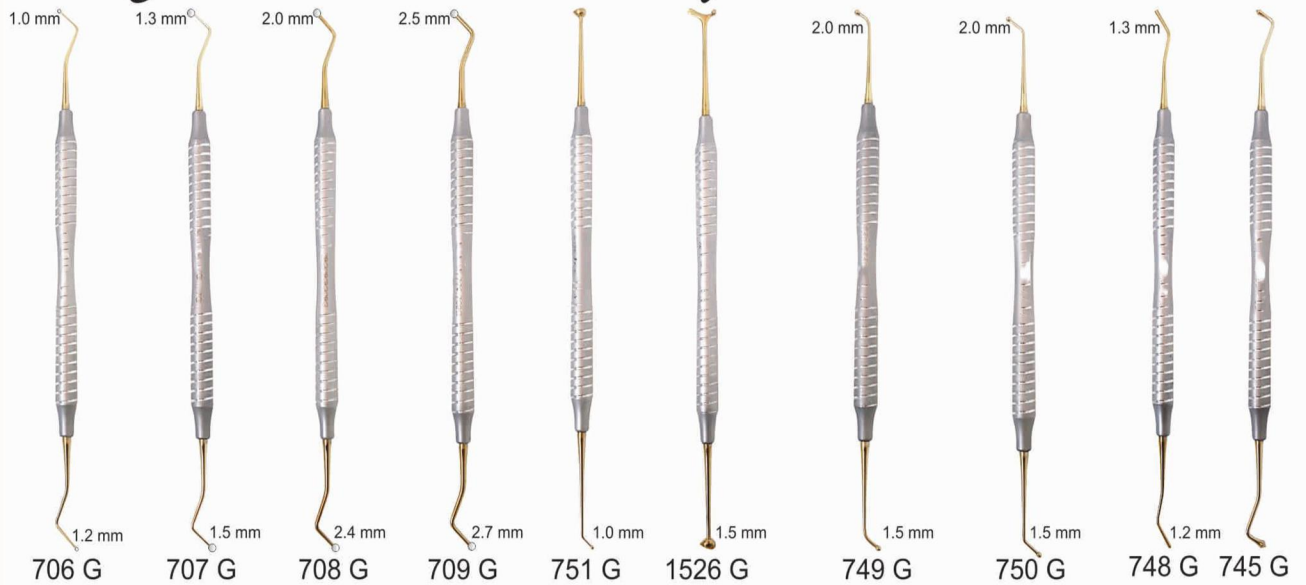

## Bone Currettes / Cucharillas Alveolares

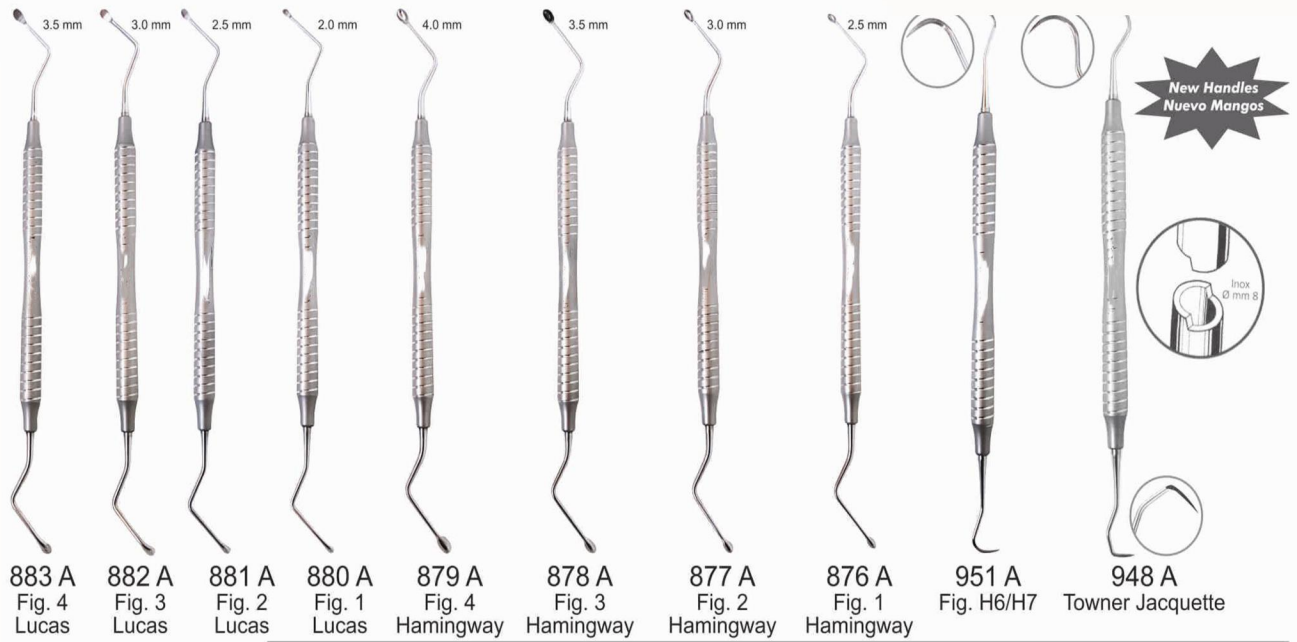

## Excavators / Exavadores / Cucharillas

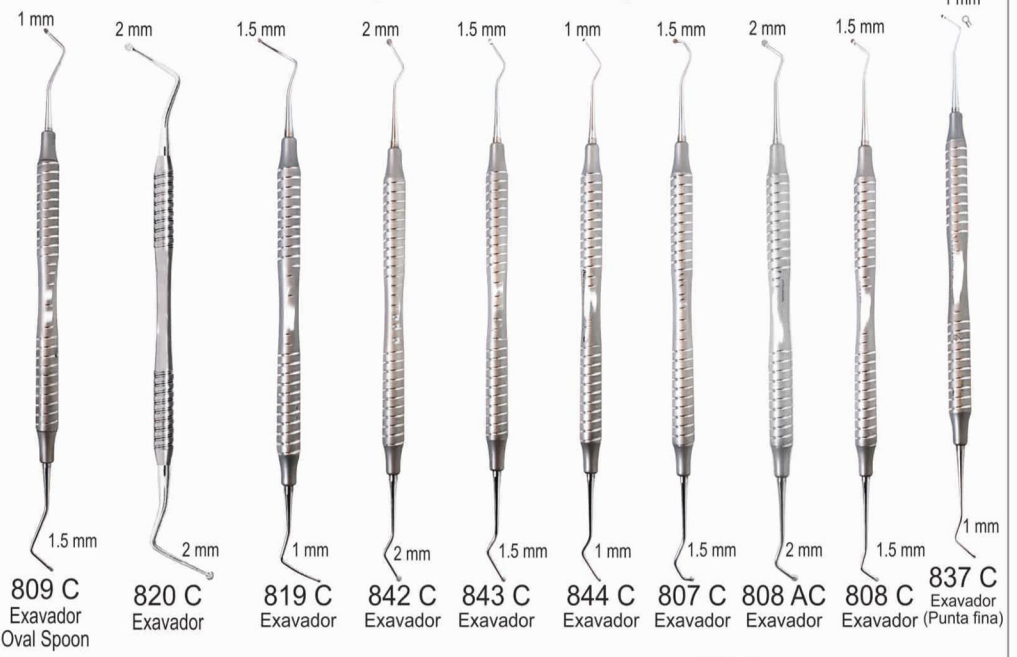

## Explorers Single / Double / Sondas Sencilla / Doble

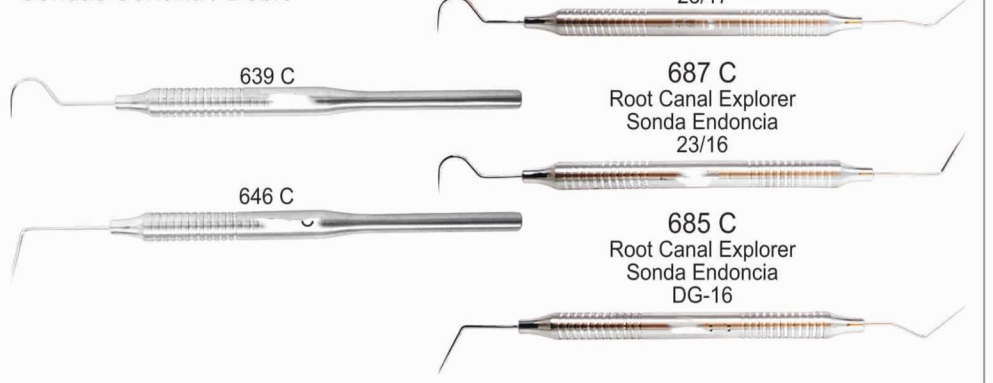

## Silicone Handle / Mango De Silicona

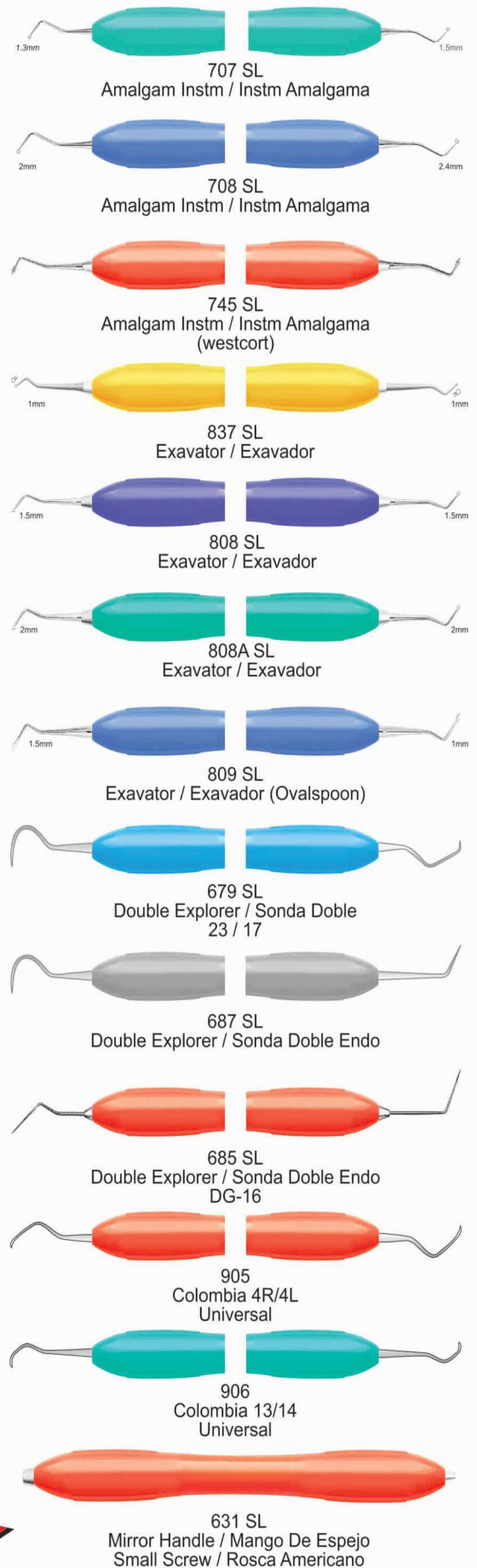
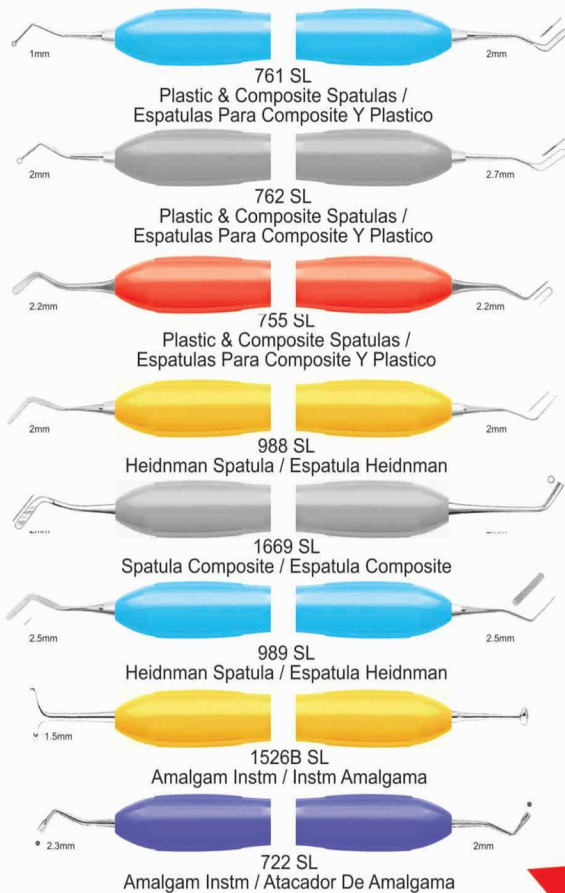
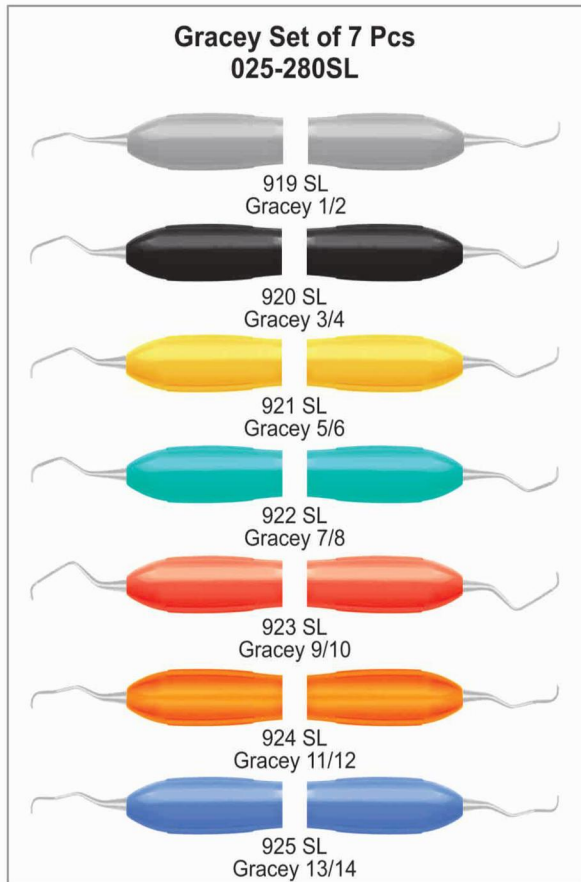

**NEW  
MASTERS  
SOFT GRIP**



# Wax & Modelling Carvers

## Instrumentos Para Cera Y Modelar

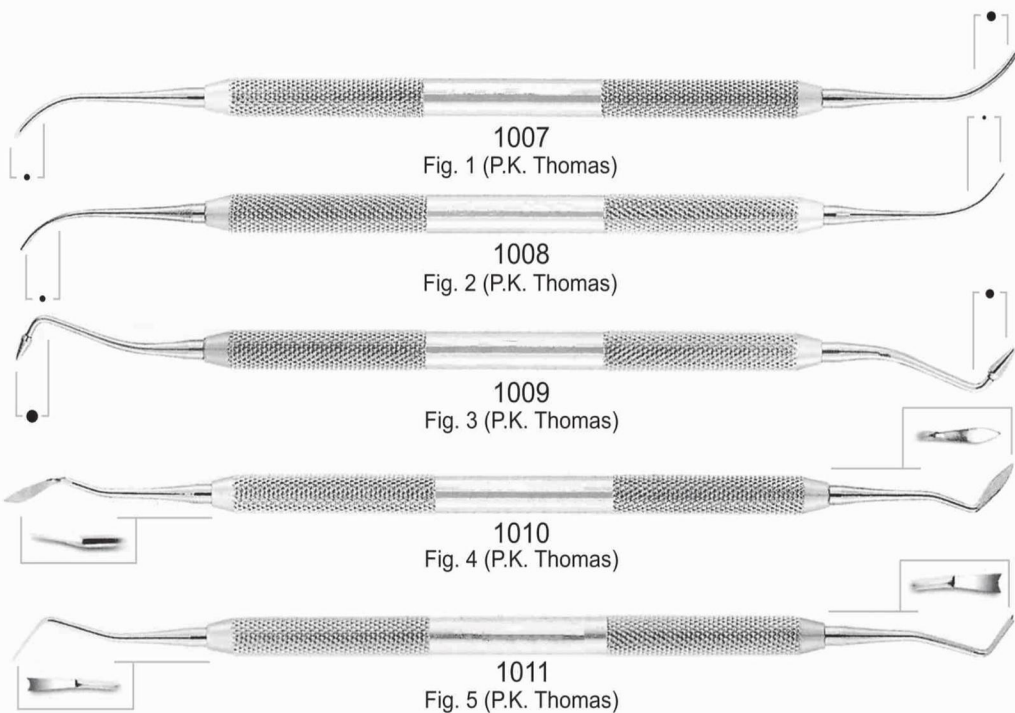
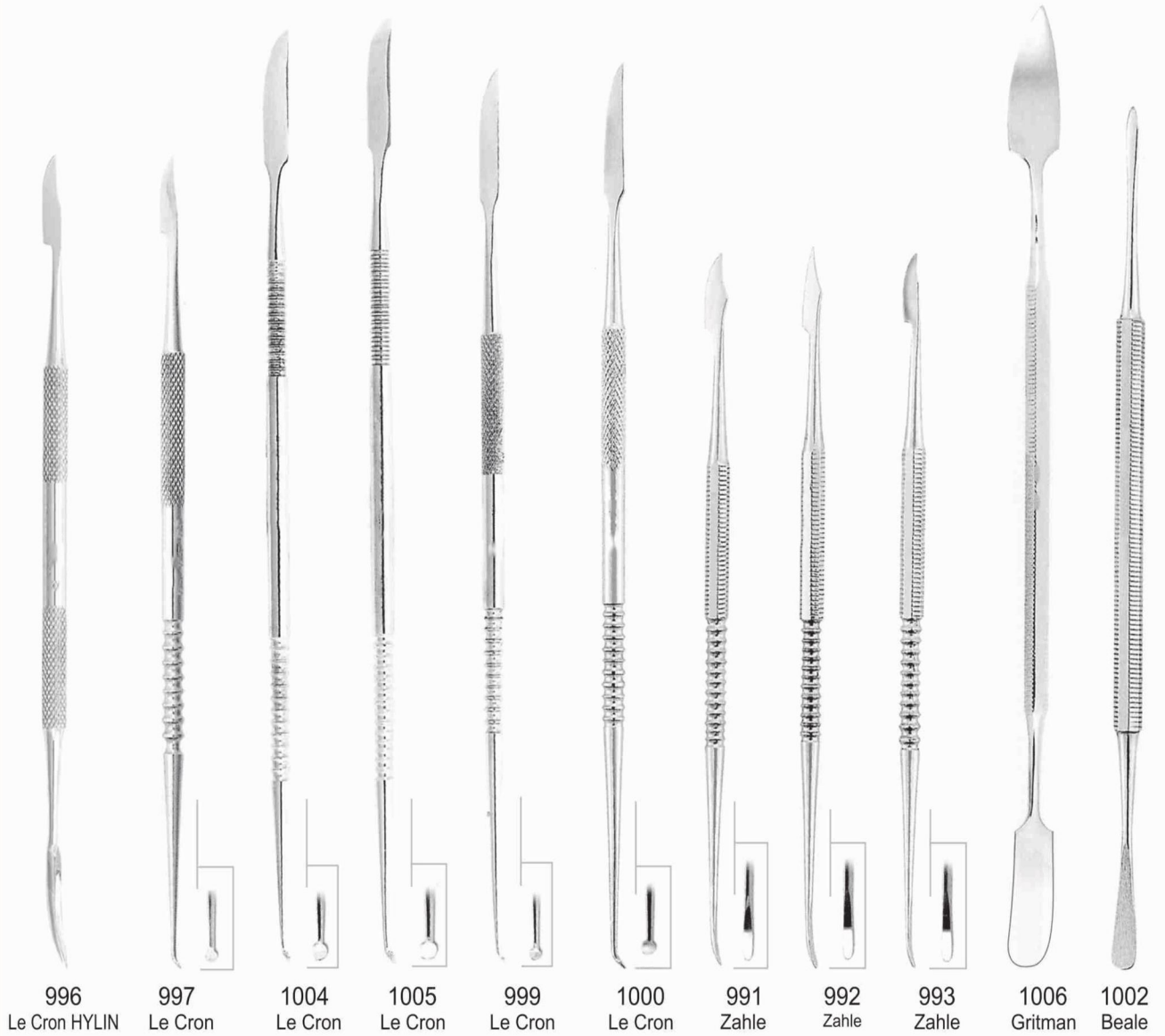

# Wax & Modelling Carvers

## Instrumentos Para Cera Y Modelar



1527 Laboratory Tweezer    1528 Laboratory Tweezer  
 1012 Fahenstock 12.5 cm    1015 Fahenstock 17 cm  
 1013 Fahenstock 12.5 cm    1016 Fahenstock 17 cm  
 1018 17 cm    1025 20.5 cm Alginato

Plastic Handle/Mango Plastico

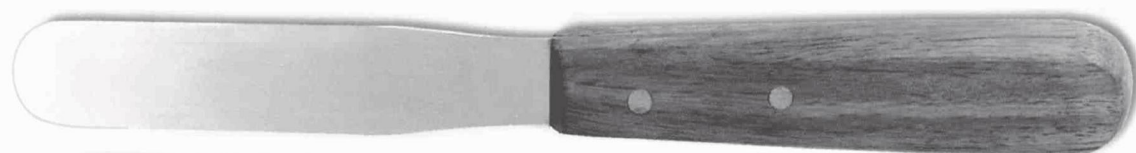

1022 20.5 cm Escayola



1020 19.5 cm

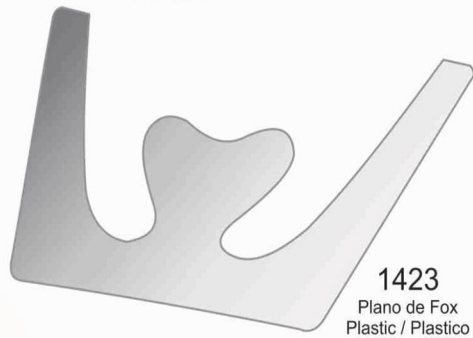

1423 Plano de Fox Plastic / Plastico

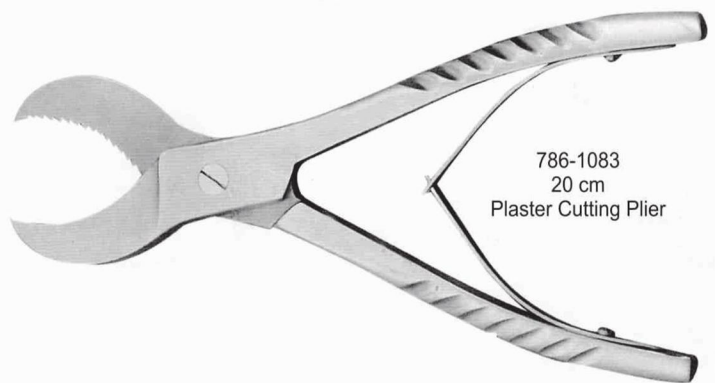

786-1083 20 cm Plaster Cutting Plier

# Laboratory Instruments

## Instrumentos Para Laboraorio



1074  
Boley  
14 cm  
Pie de Rey



1071  
Iwanson  
(For Wax)



1070  
Iwanson  
(For Metal)



1067 (Str)  
10.5 cm



1069  
Universal  
12 cm



1685  
Pie de Rey

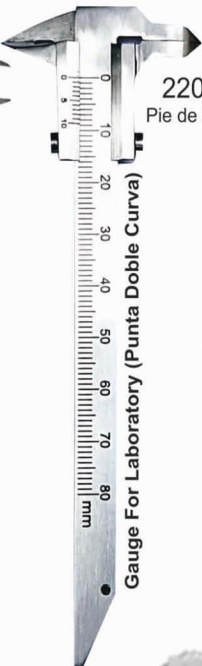

2204  
Pie de Rey



1131 B  
Medium/Mediano  
Universal (R/L)  
(izd/drha)



1129  
Parcial (L)



1130  
Parcial (R)

1068 (Curved)  
10.5 cm



028  
Articulator Full Arch  
Chrome Plated

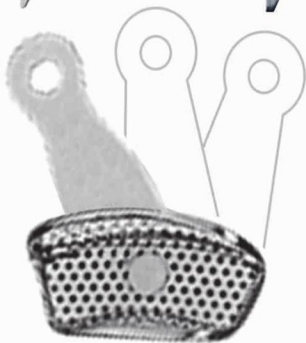

1131  
Small/Peq  
Universal (R/L)  
(izd/drha)

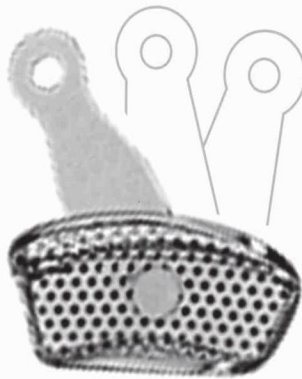

1131 A  
Medium/Mediano  
Universal (R/L)  
(izd/drha)



1127  
U1P



1127  
L1P



**Impression Trays (Rimlock)**  
**Cubetas en Acero (Rimlock)**

**Solid Partial Set of 10**  
**225-001S**

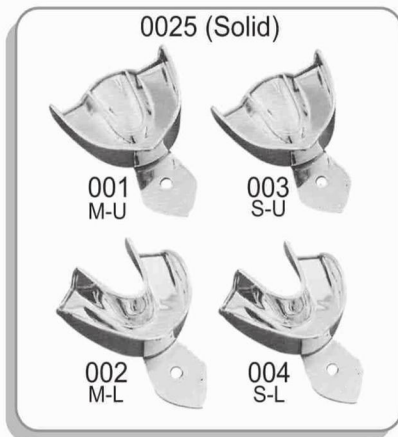
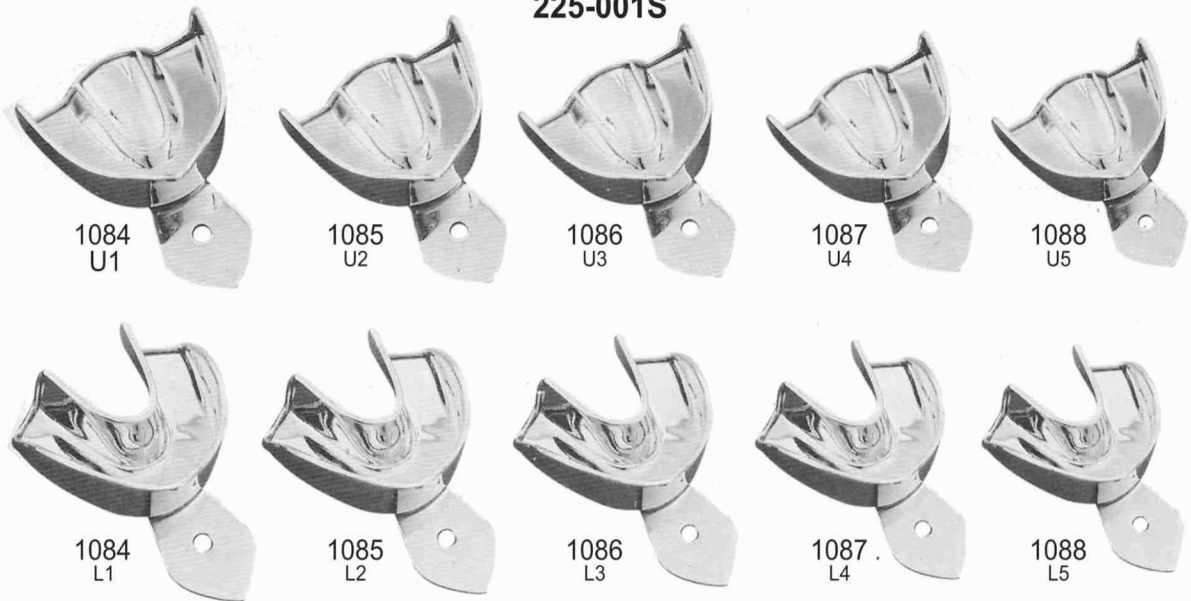

← **Set For Children**  
**Cubetas para niños** →

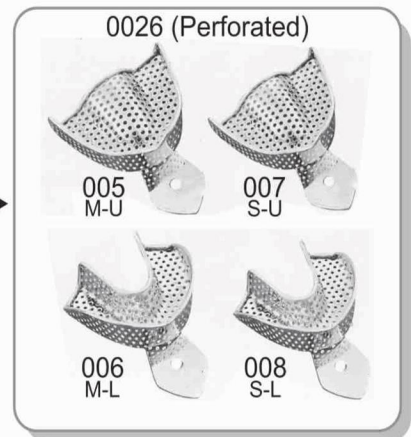

**Perforated Partial Set of 10**  
**225-010S**

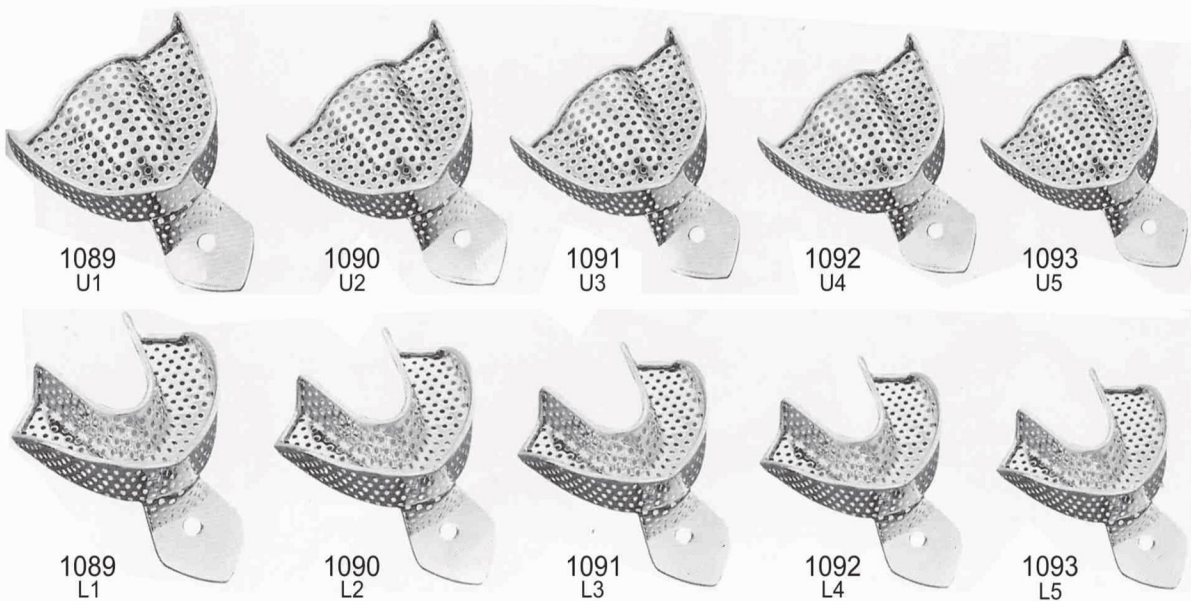

***Impression Trays (Rimlock)***  
***Cubetas en Acero (Rimlock)***

**Solid Full Denture Set of 8**  
**225-011S**

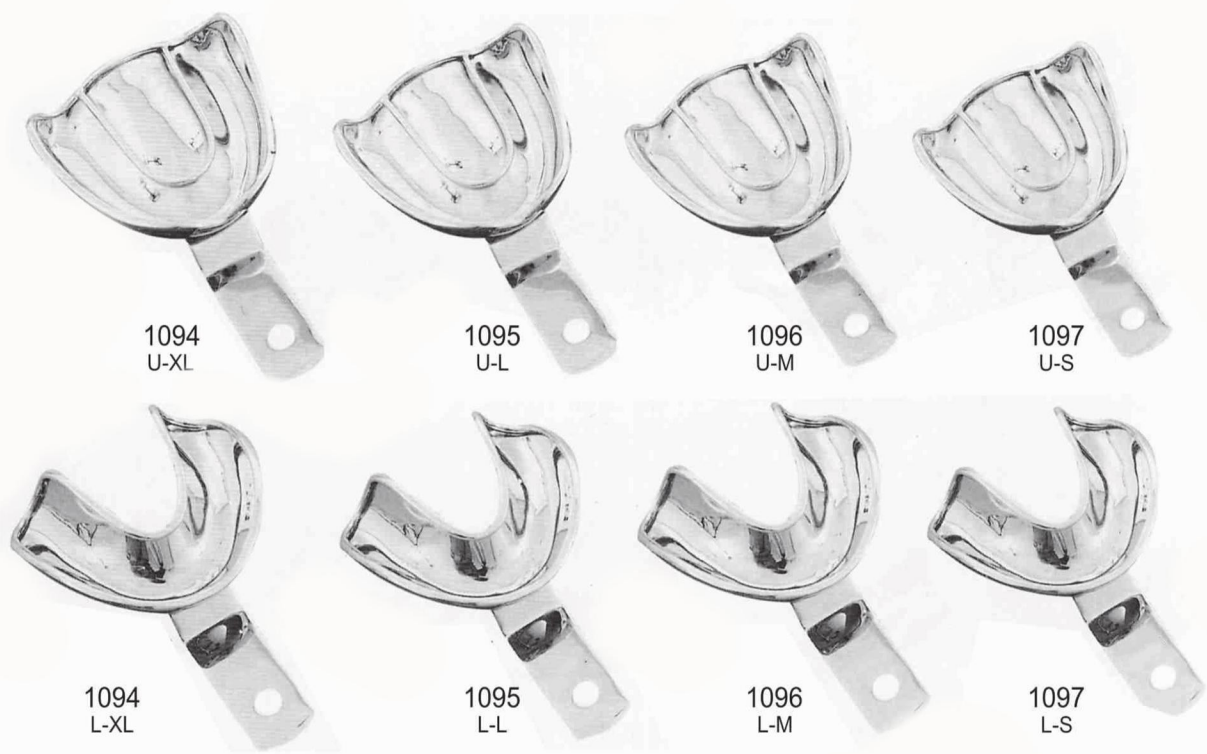

**Perforated Full Denture Set of 8**  
**225-018S**

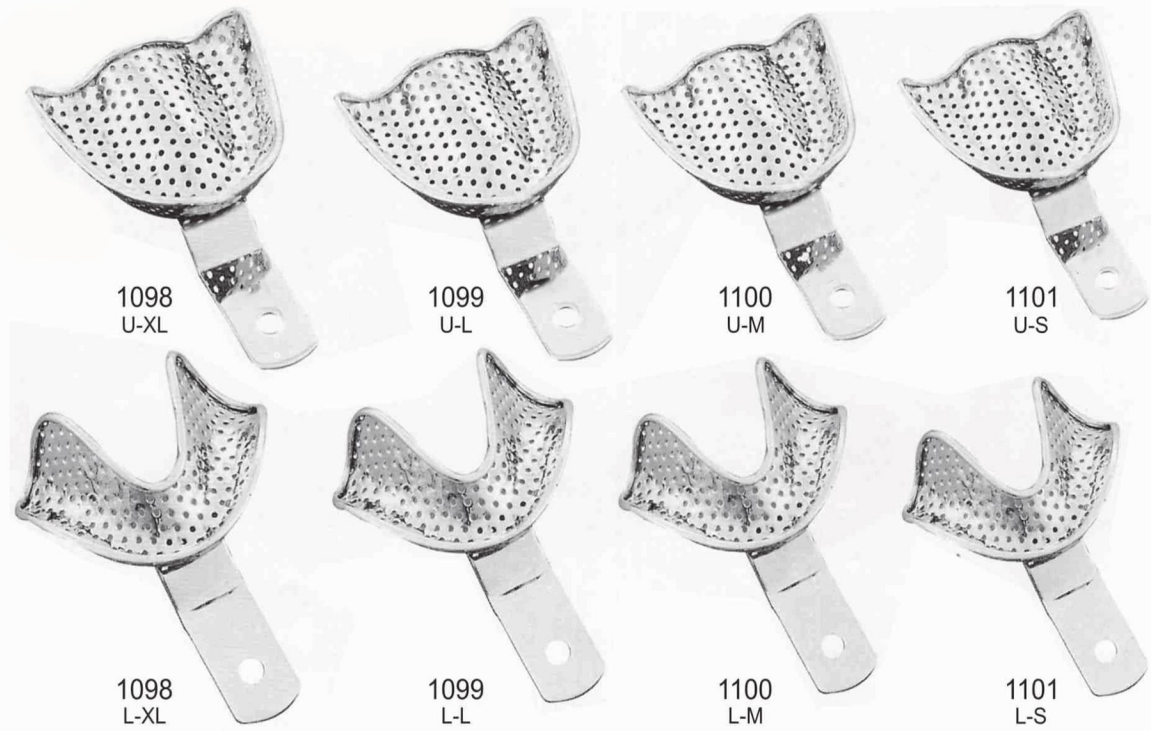



**Impression Trays "Easy Open" (inox)**  
**Cubetas Impression "Easy Open" (inox)**

225-012  
 Set of 10 pcs / Juego de 10 unid

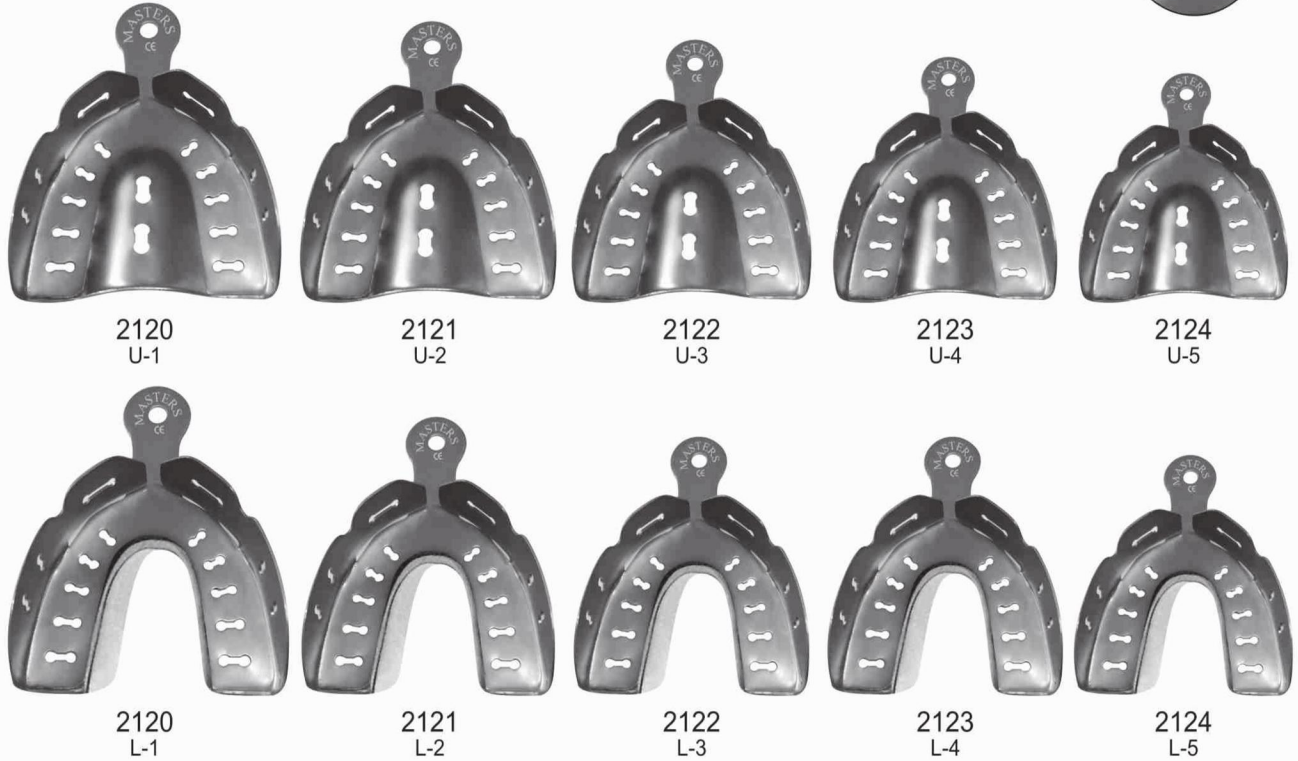
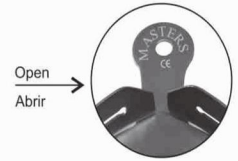

**Impression Trays "Easy Open" (inox)**  
**Cubetas Impression "Easy Open" (inox)**

225-013  
 Set of 06 pcs / Juego de 06 unid





*Rubber dam kit/  
Kit dique de goma*



*Rubber dam kit/  
Kit dique de goma*



1552  
Clamps Nos: 0, 2, 2A, 7, 8A, 9, 14, 14A



1547  
Hygienic Kit "IVORY" (Complete)  
Kit Aislamiento "IVORY" (Completo)  
Clamps Nos: 0, 2, 2A, 7, 8A, 9, 14, 14A



1441  
Dental Clamps Holder (inox)  
Fresero Para Clamps  
117x61x10 mm

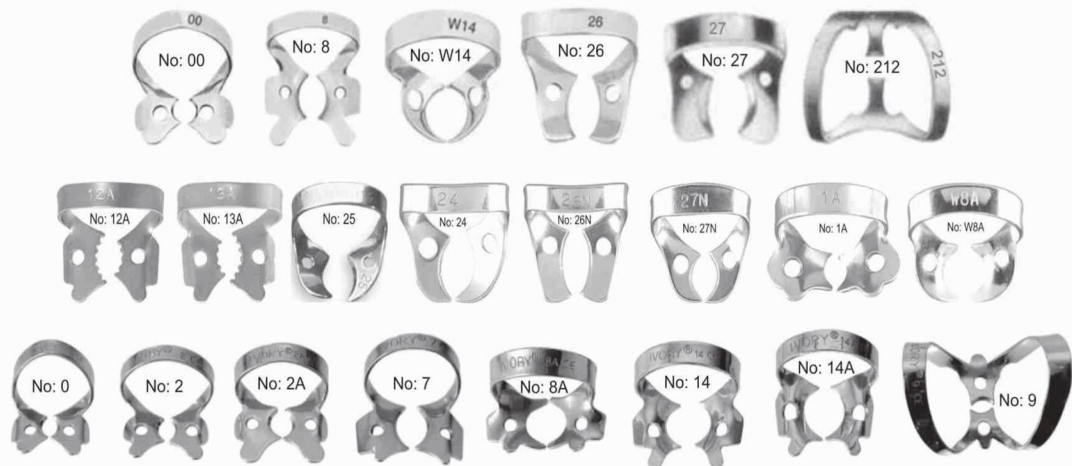

*Rubber  
Dam Items*



599  
Ainsworth  
17 cm



600  
Ivory  
17 cm



601  
Rubber Dam Frame  
10 x 10



596  
Ivory Light  
17 cm

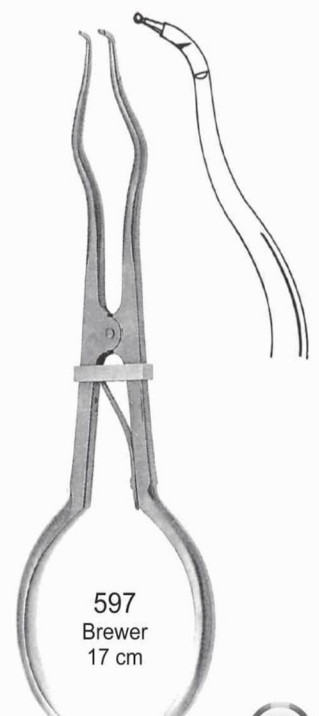

597  
Brewer  
17 cm



# Orthodontic Instruments

## Instrumentos Para Ortondoncia

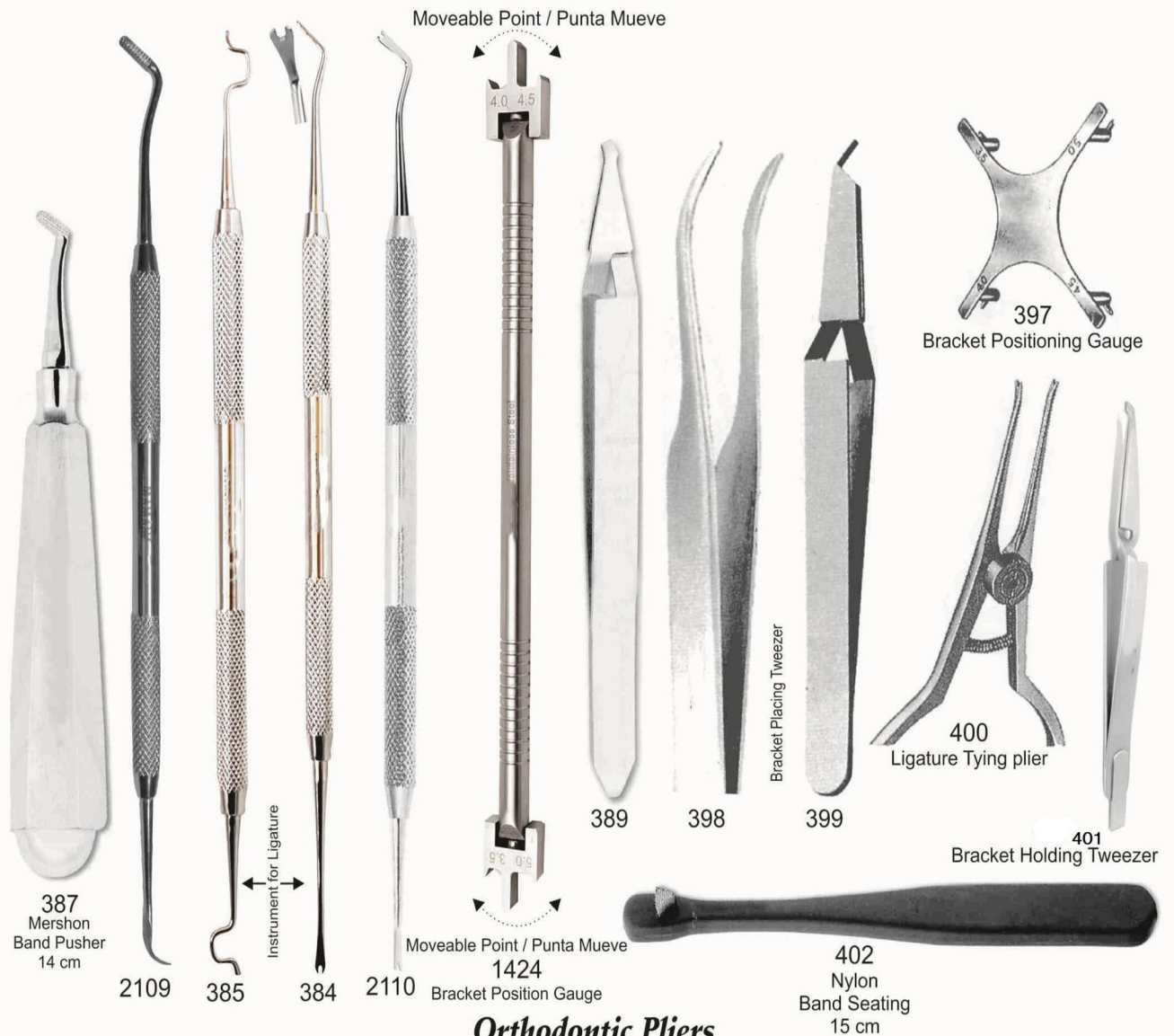

### Orthodontic Pliers

### Alicates Para Ortondoncia Y Protesis





# Orthodontic Pliers

## Alicates Para Ortodoncia Y Protesis



381  
Young  
14 cm



1530  
Johnson  
12 cm



1531  
Nance  
12 cm



1533  
Atkinson  
13 cm



342  
Universal  
16 cm



341  
Waldsachs  
15 cm



372  
13 cm



1532  
Universal  
16 cm

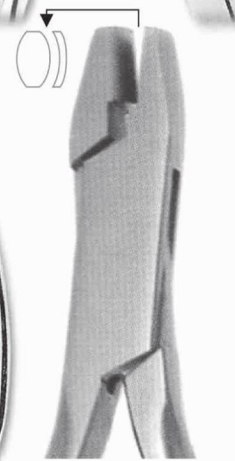

1534-A  
De La Rosa (Punta Lisa)  
13 cm



1534  
De La Rosa  
13 cm

# Orthodontic Pliers

## Alicates Para Ortodoncia Y Protesis



**369**  
Angle  
12 cm



**369 A**  
Angle with Point Marked  
12 cm



**369 B**  
Angle with Cutting Edge  
○ Maximum wire 0.05 mm



**379**  
Adams  
12 cm



**359**  
How (Angled)  
14 cm



**358**  
How  
14 cm



**380**  
Tweed Frevert  
13 cm



**1684**  
Renold  
13 cm

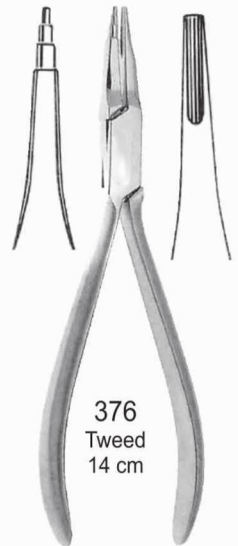

**376**  
Tweed  
14 cm



**369 T**  
Angel Plier (TC)  
12 cm

Vary hard TC point/  
Punta TC muy duro

"V" form/  
"V" forma



**1428**  
"V" Shaped Plier  
13 cm



**1427**  
Tweed 13 cm



**373**  
Nose Plier Bimler  
13 cm

# Orthodontic Pliers

## Alicates Para Ortondoncia Y Protesis



**1535**  
Band Removing Plier  
13 cm



**1536**  
Band Removing Plier  
13 cm



**1537**  
Bracket Removing Plier  
Str / Recta (13 cm)

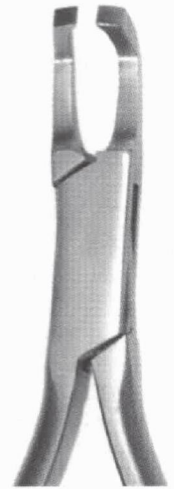

**1425**  
Bracket Removing Plier  
Cvd (13 cm)



Long Handle/  
Mango Largo

**1426**  
Distal End Cutter (TC)  
o Max 0.5 mm (.021x.025")  
□ 0.41 x 56 mm (.016" x .022")  
15 cm



**1540**  
Weingart (TC)  
Utility Plier  
13 cm



**1541**  
(Standard) TC  
Ligature Cutting Plier  
Only use soft wire Maximum .012"(.30mm)  
13 cm



**1400** (Micro) TC  
Ligature Cutting Plier  
Only use soft wire Maximum .012"(.30mm)  
12.5 cm



**1538**  
Distal End Cutter (TC)  
o Max 0.5 mm (.021x.025")  
□ 0.41 x 56 mm (.016" x .022")  
13 cm

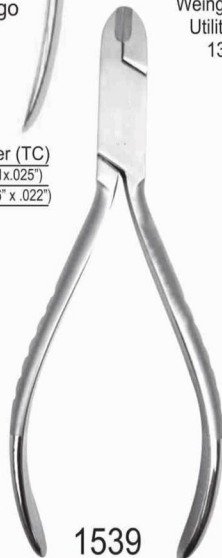

**1539**  
Hard Wire Cutter (TC) 13 cm  
o Max 0.7 mm (.020")  
□ 0.41 x 56 mm (.016" x .022")



**2117**  
Heavy Wire Cutter  
Triple (TC)  
o Max 2.0 mm



**2205**  
Band Remove Teflon Tips  
Bag of 5pcs  
Puntas Teflon Quita banda  
Bolsa de 5 unid



## Orthodontic Pliers / Alicates para ortodoncia



2006  
Crimp Pliers  
13 cm



2007  
Crimp Pliers  
13 cm



2009  
Flash Cut Pliers  
(max 0.03 mm)  
13 cm



2010  
Flash Cut Pliers  
(max 0.05 mm)  
13 cm



2011  
Step Pliers (Tc)  
Wire bending 1mm  
13 cm



2011 A  
Step Pliers (Tc)  
Wire bending 0.50mm  
13 cm

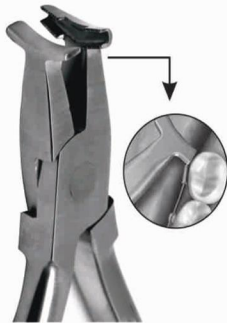

2012  
Cinch Back Pliers  
Alicate para doblar arcos  
13 cm



2013  
Torqut Pliers (Male)  
13 cm



2014  
Torqut Pliers (Female)  
13 cm



2008  
Flash Cut Pliers  
(Universal)  
13 cm



Stainless Steel Wire Tubes/  
Varilla de acero en tubos  
10 pcs / 10 unid

Ref. Nos.	Sizes
060	0.4 mm
061	0.7 mm
062	0.8 mm
063	0.9 mm
064	1.0 mm



2016  
Ortho Pliers stand  
20 cm

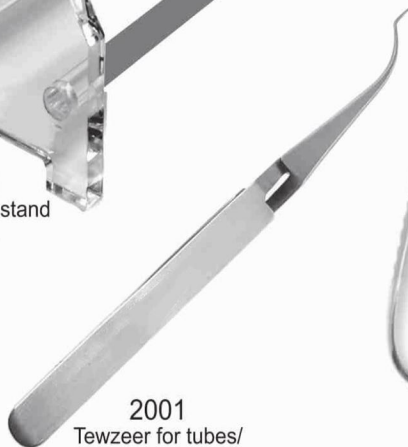

2001  
Tewzeer for tubes/  
pinza para tubos



0050  
Mathieu (Curved)



465  
Mathieu (fine/ fino)  
14 cm



465 (TC)  
Mathieu (fine/ fino)  
14 cm

New

<p>2095 A Rubber Dam Frame Plastic (Autoclavable)</p> <p>Plastico</p>	<p>2096 A Rubber Dam Frame Plastic (Autoclavable)</p> <p>Plastico</p>	<p>Eyes Protection Goggles Gafas Para Proteccion</p> <p>Plastico</p> <p>Color Disponible Transparente, Naraja,</p> <p>2097-A</p>	
<p>2098 Burs Holder / Fresero 24 Holes for FG Handle (Autoclavable)</p> <p>Plastico</p>	<p>2099 Burs Holder / Fresero 10 Holes for FG Handle 50 Holes RA Handle (Autoclavable)</p> <p>Plastico</p>	<p>2100 Dappen Dishes / Vaso Dappen</p> <p>Glass / Cristal</p>	
<p>2101 Endo File Box Aluminum 118x83x50mm (Autoclavable)</p> <p>Plastico</p> <p>35 holes</p> <p>Colour Available / Color Desponible: Blue &amp; Red / Azul y Rojo</p>	<p>2102 Endo File Holder 155x60x35mm (Autoclavable)</p> <p>Plastico</p>	<p>2103 Endo File Holder 10x2.4x3.2cm (Autoclavable)</p> <p>Plastico</p>	
<p>2104 (No Autoclavable)</p> <p>"O" Style Cheek Retractors Abre boca tipo "O"</p> <p>Plastico</p>	<p>2105 Cheek Retractors Abre Boca (Autoclavable) Kit de 2 unid / Kit of 2 pcs</p> <p>Plastico</p> <p>Child / Niño</p> <p>Adult / Adulto</p> <p>2105 B Cheek Retractors Abre Boca (Autoclavable) Kit de 2 unid / Kit of 2 pcs</p>	<p>2112 B Adult / Adulto</p> <p>2112 Child / Niño</p> <p>Cheek Retractors Abre Boca (Autoclavable) Kit de 2 unid / Kit of 2 pcs</p>	
<p>Mirror Photographic (Surface) Espejos Fotografia (Rodio)</p> <p>Glass / Cristal Double Face / Doble Cara</p> <p>3051 → Espejos Linguales (A) XL 131mm largo y 66 mm ancho</p> <p>3052 → Espejos Linguales (B) NIÑO 81 mm largo y 54 mm ancho</p> <p>3053 → Espejos Linguales (C) Bucal 145x38x41mm</p> <p>3053-A → Espejos Linguales (D) Letrales</p>	<p>2106 Endo Feet Aluminum / Regla Endo Aluminio</p>	<p>2107 Amalgum Carrier</p> <p>Plastico</p>	<p>2108 Napkin Holder / Porta Servilletas (Flexible)</p> <p>Plastico</p> <p>Excellent Flexibility</p>





Mouth opener (Rubber / Goma)  
 021 (Small /peq)  
 022 (Medium / med)  
 023 (Large / grande)  
 Autoclave: No  
 Only wash with warm water & Shampo  
 (Solo limpio con agua caliente y jobon)

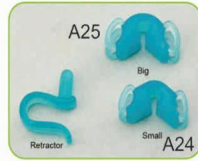

Mouth opener (silicon)  
 A24 (Small /peq)  
 A25 (Big / grande)  
 Autoclavable 134°

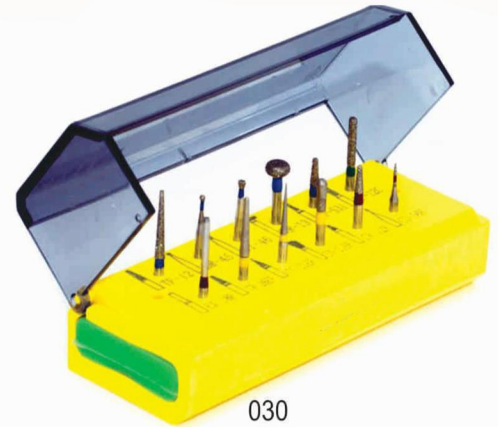

030  
 FG bur holder (Plastic/Plastico)  
 Autoclavable 134°



Mouth opener (Plastic / Plastico)  
 019 (Adult / Adulto)  
 Autoclave: No  
 Only wash with warm water & Shampo  
 (Solo limpio con agua caliente y jobon)

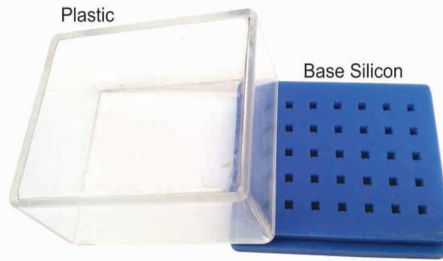

2206  
 Bur Holder (FG & RA)  
 Silicon & Plastic  
 Autoclavable Base Silicon 134°



029  
 Retractor para Foto Oclusal con diseño innovador. Su mango curvado permite la retracción labial. Autoclavable 134°C  
 1 pcs / 1 unid



027  
 Cheek Retractor (Adulto / Niño)  
 (Plastic / Plastico)  
 Set of 2pcs / kit de 2 unid  
 Autoclavable 134°



2201  
 Study Model (Adult / Adulto)  
 (Typodonto) 32 Teeth / 32 dientes  
 without Articulator / Sin articulador



2202  
 Study Model (Adult / Adulto)  
 (Typodonto) 32 Teeth / 32 dientes  
 with Articulator / Con articulador



2200  
 Study Model (Child / Niño)  
 (Typodonto) 24 Teeth / 24 dientes  
 with Articulator / Con articulador



2203  
 Reposicion (Adult / Adulto)  
 (Typodonto) 32 Teeth / 32 dientes  
 Packing / Embalaje: in bag / en bolsa



## New Products / Producto Nuevo



**054**  
Endo File Ring (Aluminum)  
Anillo Para lima Endo (Aluminio)  
Autoclave 134°C

**053**  
Matrices Box (Inox)  
100 Pcs (Medium Hard)  
Caja Matrices (Inox)  
100 Unid (Duro Mediano)



**052**  
Dispensing Impression Gun  
1:1/1:2(50ml)

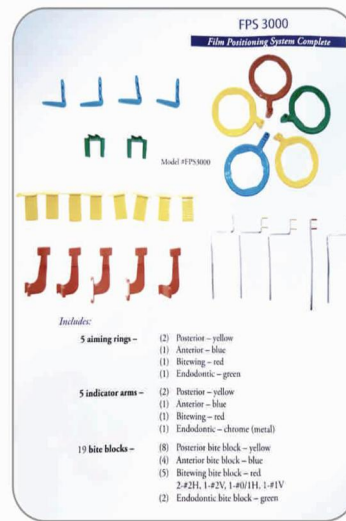

**051**  
Film positioning System Complete  
Sistema posicionador de radiografía completo



## KEY RINGS / LLAVEROS



KR-1



KR-2



KR-3



KR-4



KR-5



KR-6



KR-7



KR-8



KR-9



KR-10



KR-11

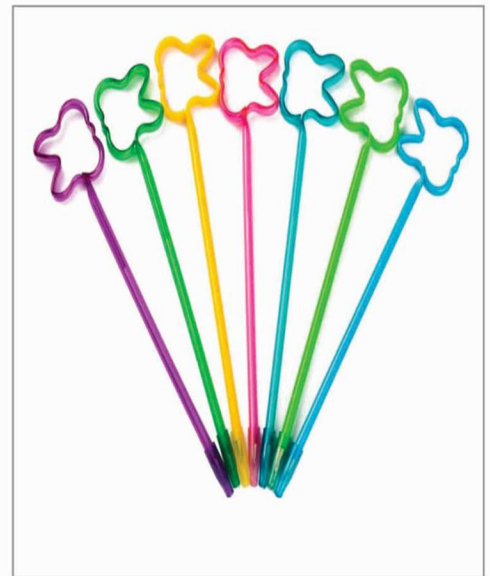

KR-12

Tooth Shape Ball Pen (Available 25 Pcs Bag)  
Bolígrafo con forma de diente (Disponible Bolsa de 25 unid)

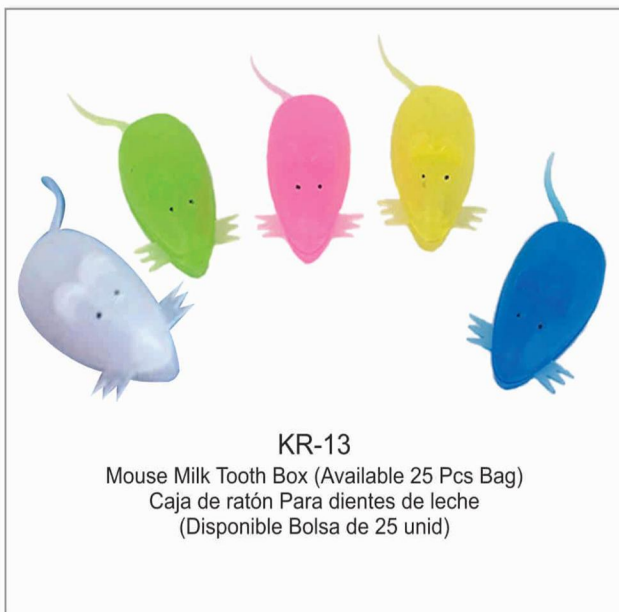

KR-13

Mouse Milk Tooth Box (Available 25 Pcs Bag)  
Caja de ratón Para dientes de leche  
(Disponible Bolsa de 25 unid)



KR-14

Milk Tooth Box (Available 25 Pcs Bag)  
Caja Para dientes de leche  
(Disponible Bolsa de 25 unid)



## New Products / Nuevo Productos

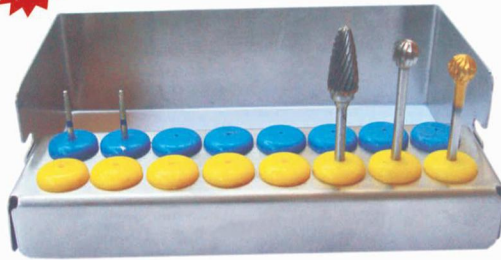

1575

Bar Holder (inox, Silicon) autoclave 160°  
Fresero (fresas, contra angulo, pieza de mano)



1151

Cotton Holder (inox)



1154

Spirit Lamp (inox)

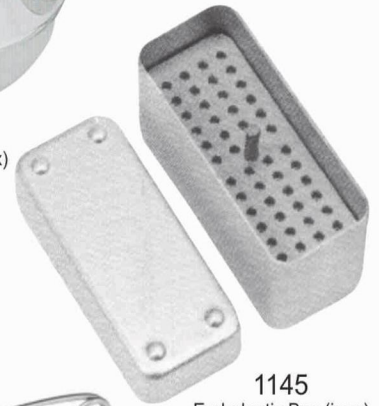

1145

Endodontic Box (inox)



1429A

Mixing Bowl Inox  
60 mm



1429

Mixing Bowl Inox  
30 mm



055

Burr Wash Holder inox



2116

Identification Rings  
Aros Para Identificador  
Colour Available / Color Disponible  
Yellow, Red, Green, Blue, White.  
Amarillo, Rojo, Verde, Azul, Blanco.  
(Autoclavable)  
Pack 50 Pcs / 50 Unid

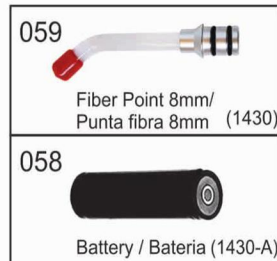

1430

Led Curing Light

Feature:

1. High articulation optical fiber (08 mm)
2. Three working modes: strong, gradually strong, flashing
3. Optional working time: 05s, 10s, 20s, 30s, 40s
4. Light intensity: 1500mw/cm<sup>2</sup>
5. Automatic inactive, automatic power off.

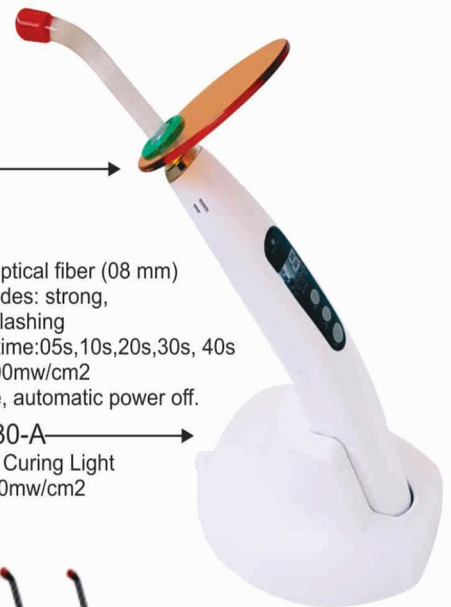

1430-A

Led Curing Light  
1800mw/cm<sup>2</sup>

1430-B

Led Curing Light (Colour)

Feature:

1. High articulation optical fiber (07 mm)
2. Three working modes: strong, gradually strong, flashing
3. Optional working time: 15s, 20s, 25s
4. Light intensity: 1500mw/cm<sup>2</sup>
5. Automatic inactive, automatic power off.

Colour Available:

Silver, Purple, Orange, Green,  
Black, Golden.

Colores Disponible:

Aplata, Morado, Naraja, Verde,  
Negro, Oro.

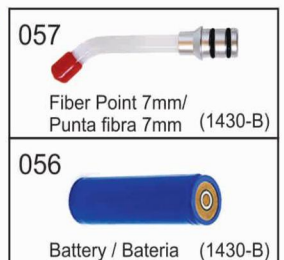

057

Fiber Point 7mm/  
Punta fibra 7mm (1430-B)

056

Battery / Bateria (1430-B)



1151  
Cotton Holder (inox)

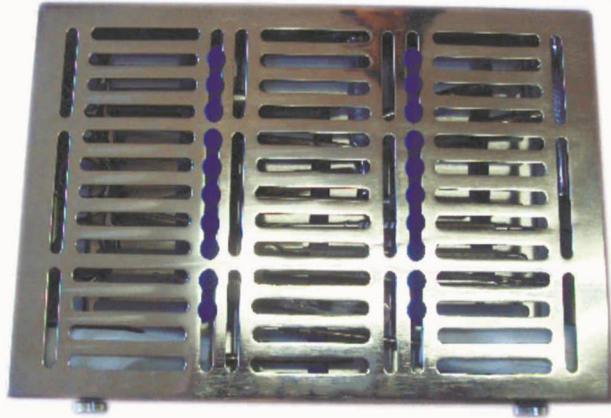

1576  
29x18.5x3.50cm  
Sterilize Trays Large INOX



1666  
5 Pcs

Sterilize Trays INOX

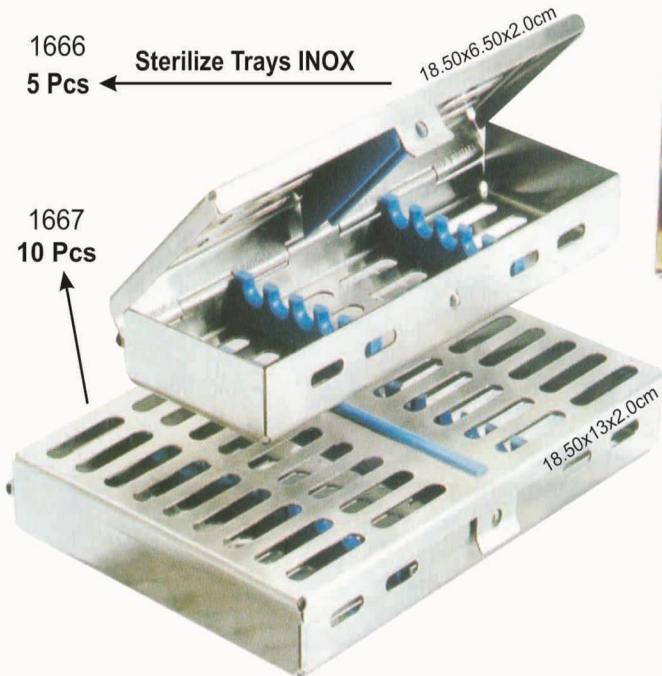

1667  
10 Pcs



1666-B  
Sterilize Trays INOX  
7-Pcs

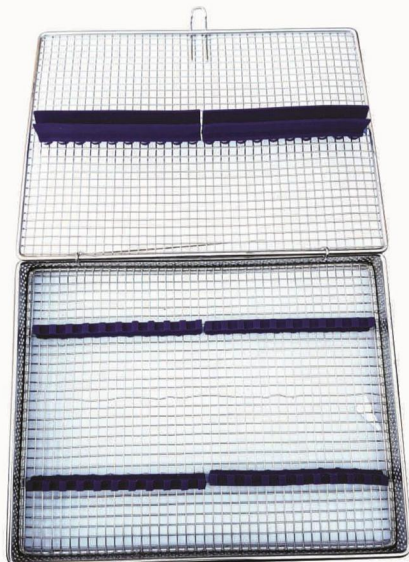

014-B  
Instruments Tray 20pcs (Inox)  
15x19.5x3.5cm

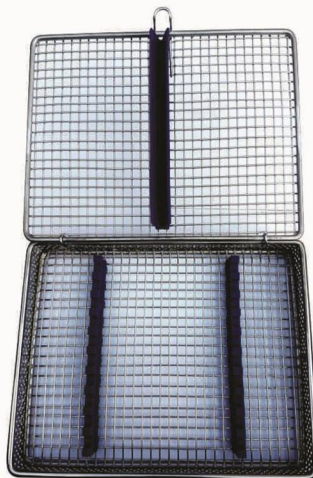

015-B  
Instruments Tray 10pcs (Inox)  
20x14.5x3.5cm



016-B  
Instruments Tray 07pcs  
20x10.5x3.5cm  
(Inox)

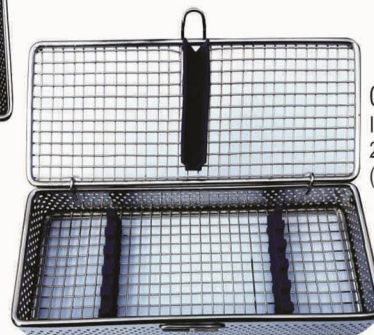

017-B  
Instruments Tray 05pcs  
20x8x3.5cm  
(Inox)



# Ultrasonic Scaling Scalar / Punta ultrasonido



## Scaling (Used for SIRONA)

GS1			
	Supragingival scaling		
GS2			
	Supragingival scaling		
GS3			
	Supragingival scaling		
GS4			
	Supragingival scaling		



compatible with SATELEC scaler  
**HD-7L**  
Handle with LED / Mango con luz

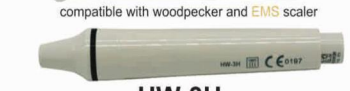

compatible with woodpecker and EMS scaler  
**HW-3H**  
Handle without LED / Mango sin luz



compatible with SATELEC scaler  
**HD-7H**  
Handle without LED / Mango sin luz

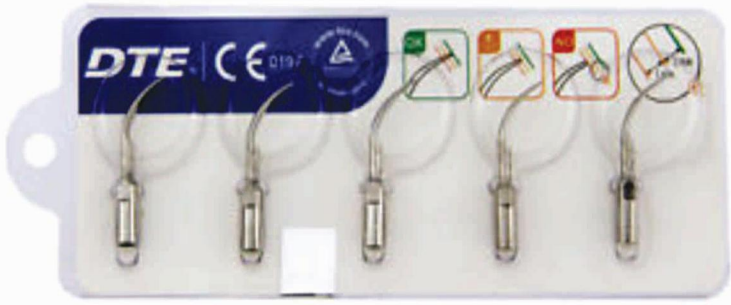

Available only blister of 5 pcs/  
Solo disponible bolister de 5 unid



Torque Wrench / Llave

041	EMS
042	SATELEC
043	SIRONA

## Rotary Products / Producto Rotatorios



**044**  
Dental High Speed Hand piece.  
Spray holes: 4. Super Torque head.  
300,000 - 400,000 rpm.(25-30psi)  
Push button type.  
Bearing: Advanced bearing.  
Air pressure: 25-30 psi.  
Bur size ISO-standrad.ø1.59-1.60mm  
Autoclave 134 (15-minute)



**045**  
Low-speed Air Turbine Handpiece  
E-Type low speed 1:1  
Internal cooling system  
Air Pressure: 245-392kpa  
Atomized Air Pressure: 200kpa  
Rotation speed: 16000-20000rpm/min  
Press button/manual operation  
Bur size: ø2.334-2.350mm  
Autoclave 134 (12-minute)



**046**



**047**





**4 Holes**



**048**  
Rotary Kit complete

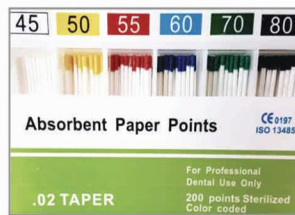

**010**  
Punta Papel



**011**  
Punta Papel



**012**  
Punta Gutta Percha



**013**  
Punta Gutta Percha

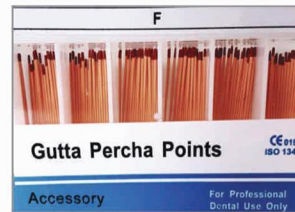

**016**  
Punta Gutta Percha (Fino)



**014**  
Punta Gutta Percha (Doble Extra Fino)

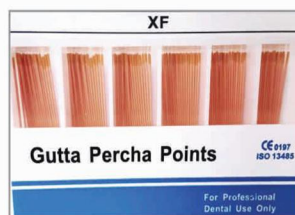

**015**  
Punta Gutta Percha (Extra Fino)



**017**  
Punta Gutta Percha (Surtido)



# Implant Instruments

PERIOTOMOS

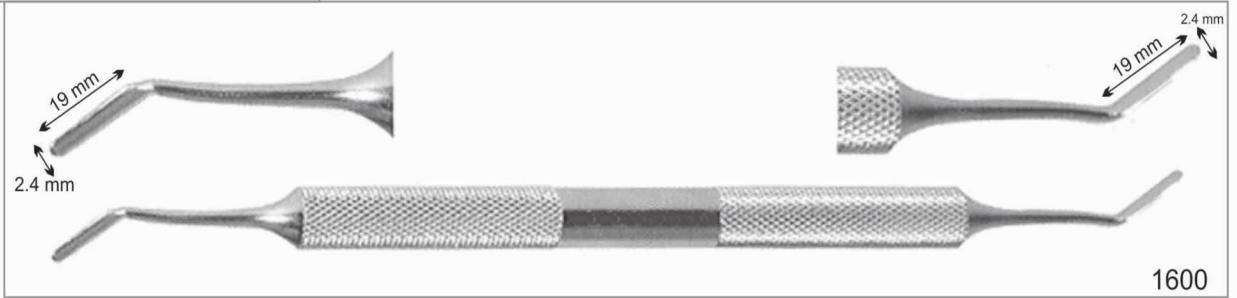

PERIOTOMOS

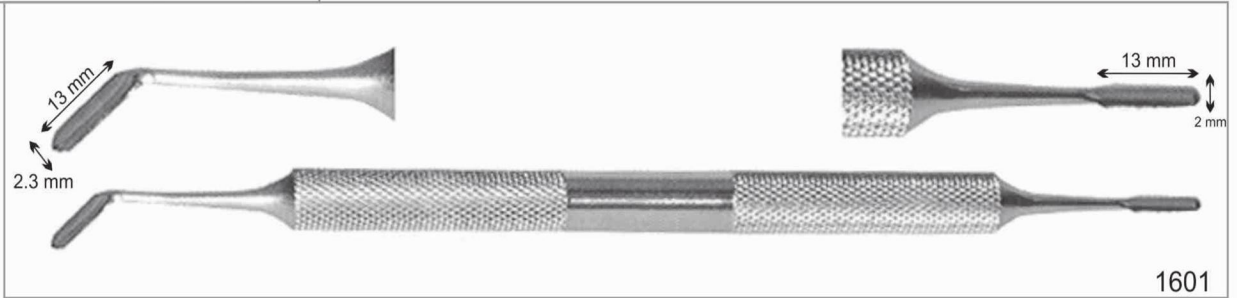

PERIOTOMOS



PERIOTOMOS

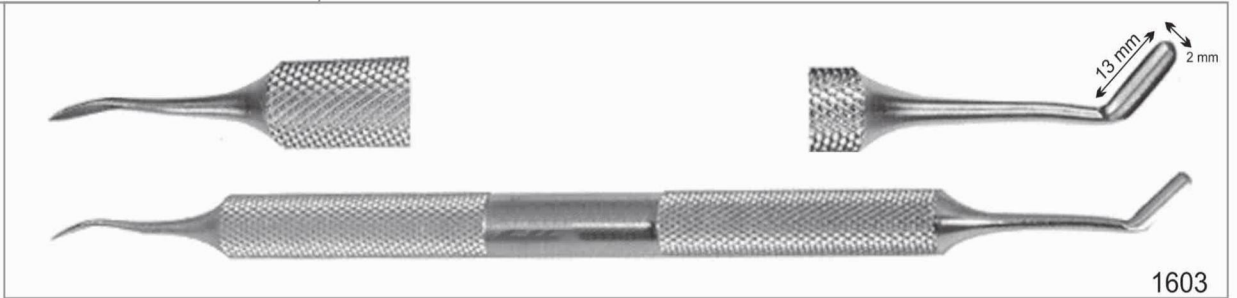

PERIOSTOTOMOS

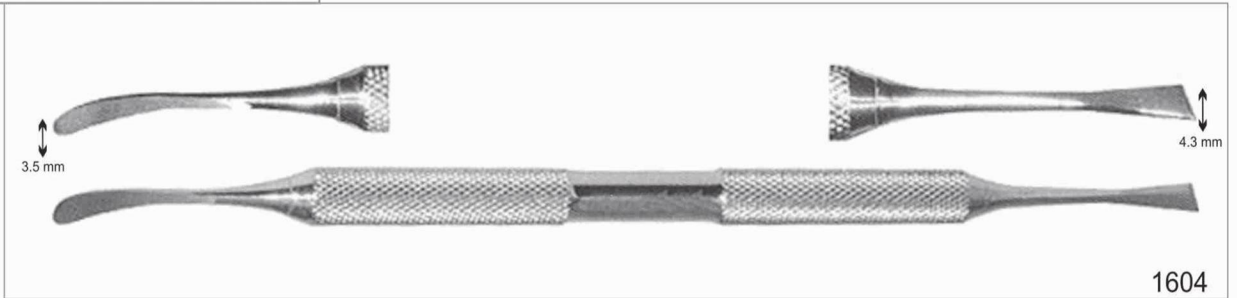

## Implant Instruments

### PERIOSTOTOMOS

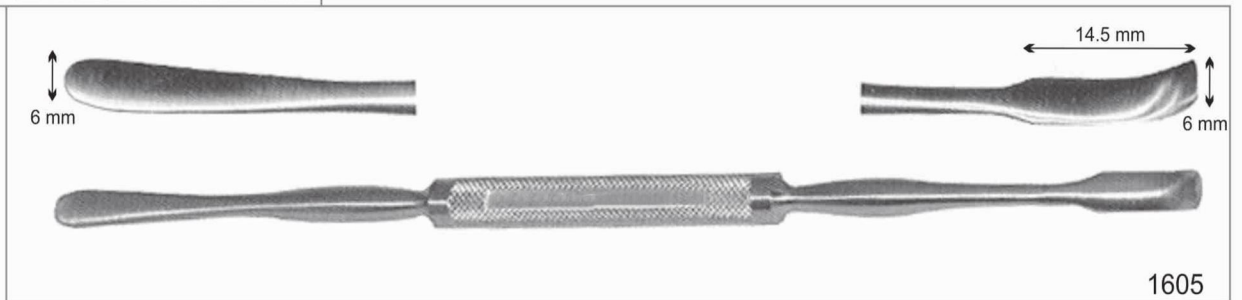

### PERIOSTOTOMOS



### DESPEGADOR PERIÓSTICO



### CURETAS OSEAS CUCHARILAS DE LEGRADO

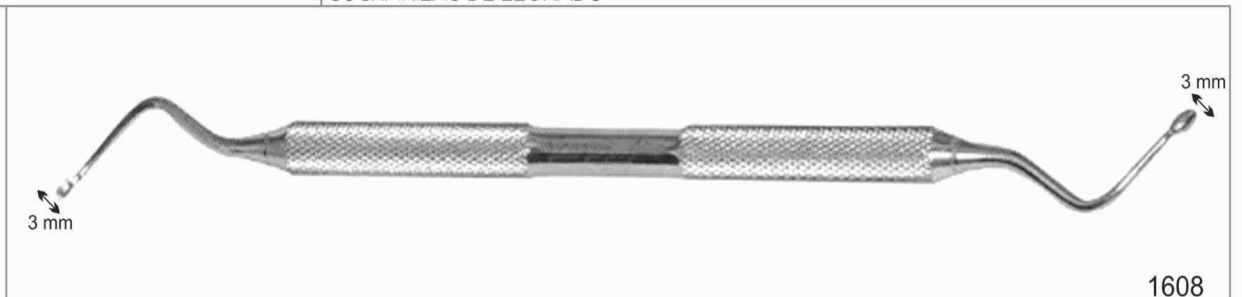

### CURETAS OSEAS CUCHARILAS DE LEGRADO



## Implant Instruments

PINZA DE CAMPO

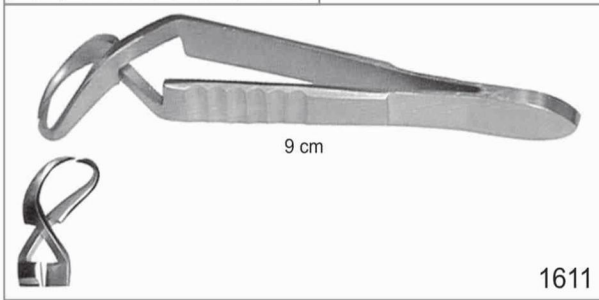

PINZA MOSQUITO



TWZ BROWN

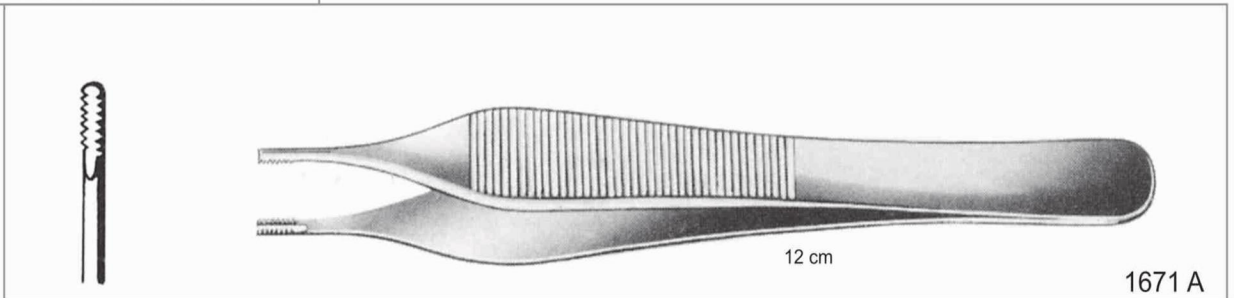

PINZA ADSON

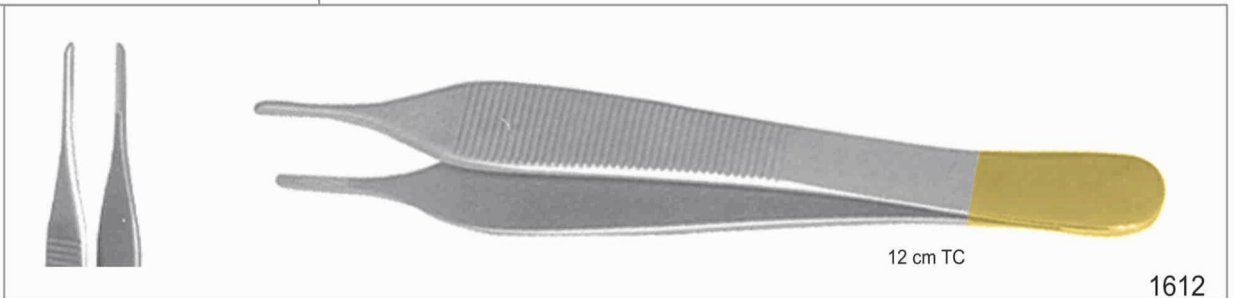

PINZA DE DISCCION BAKEY

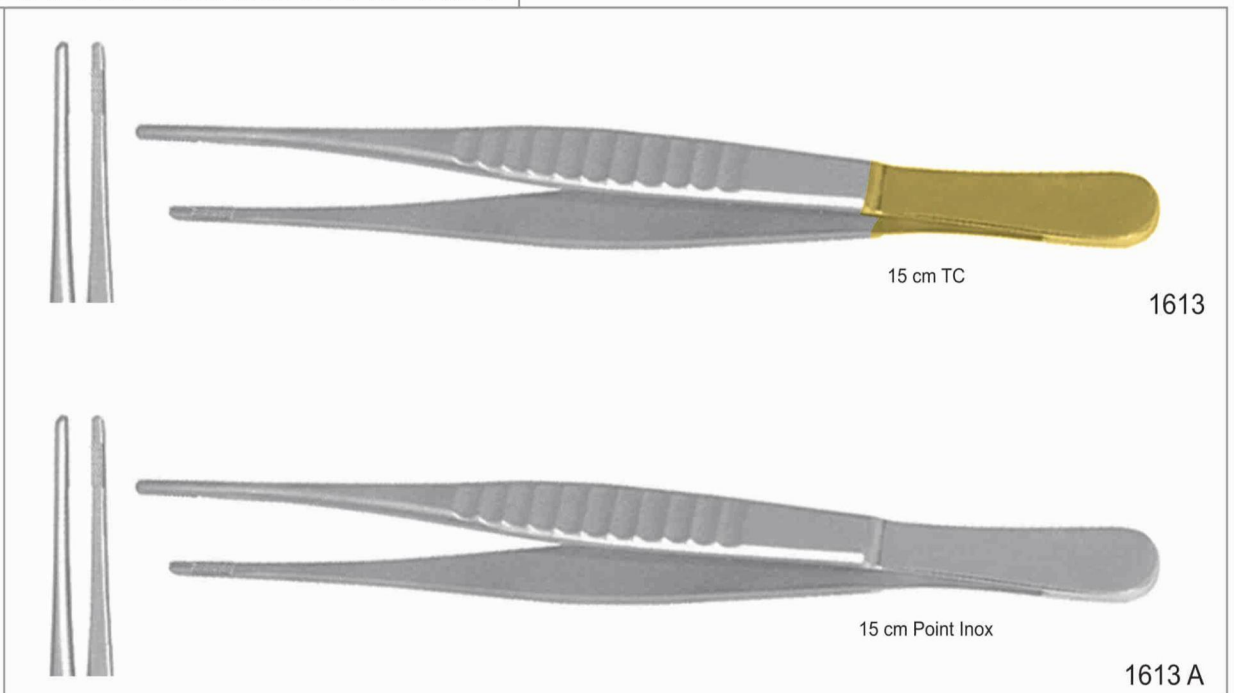



## Implant Instruments

### COMPÁS QUÍRURGICO

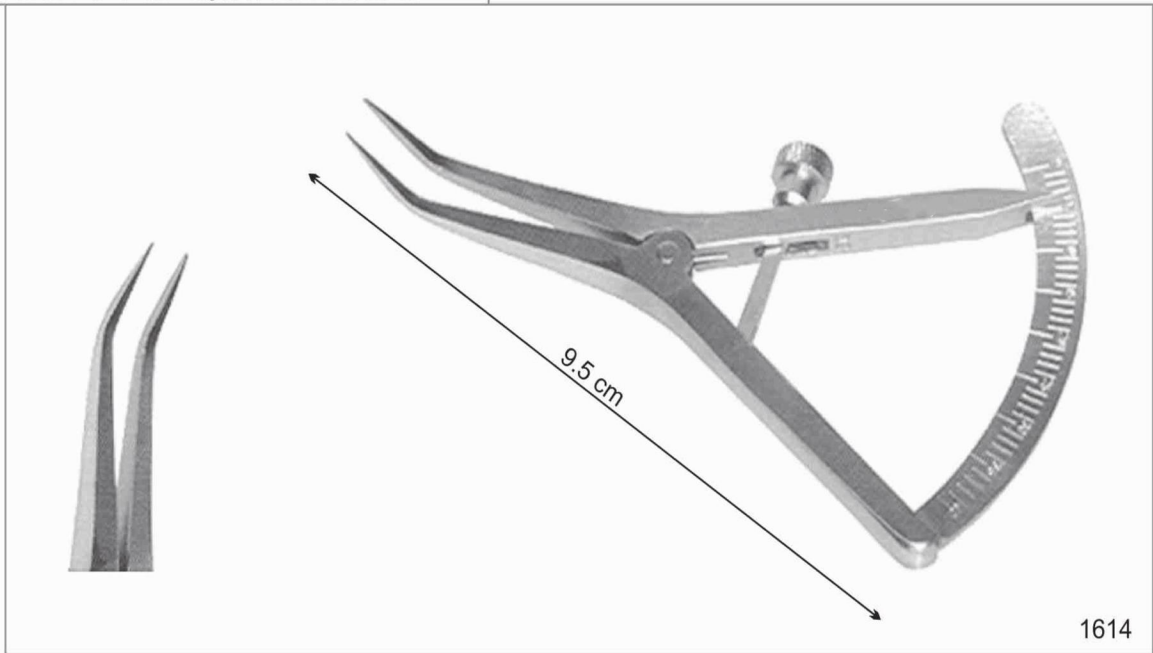

### REGLA QUIRÚRGICA

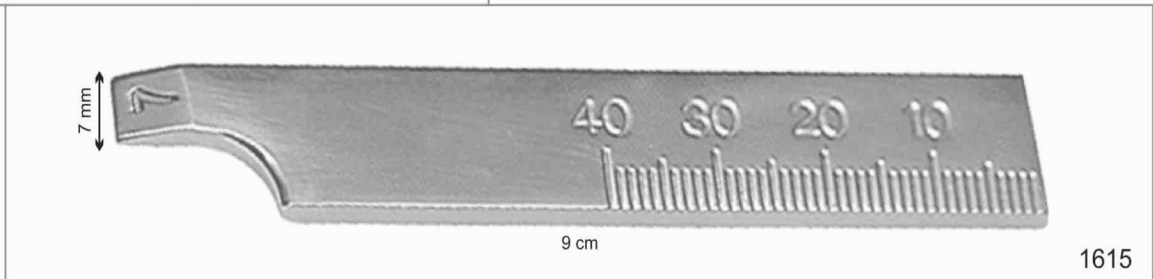

### TIJERA PARA MICROCIURUGÍAS



### TIJERA PARA MICROCIURUGÍAS CURVA

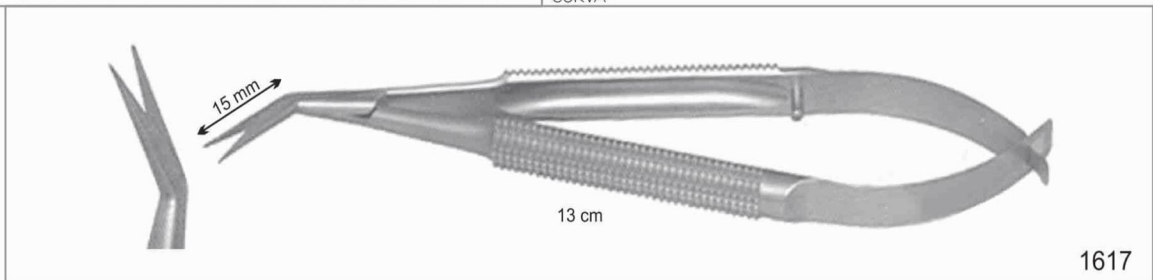

## Implant Instruments

### TIJERA DE TEJIDOS

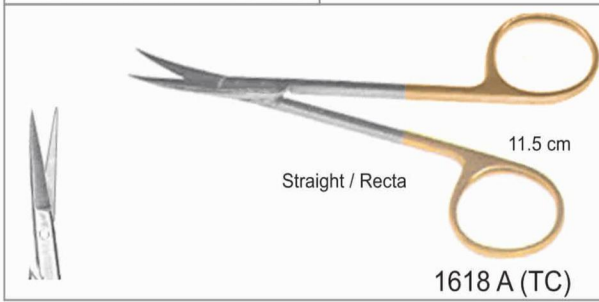

### TIJERA DE TEJIDOS

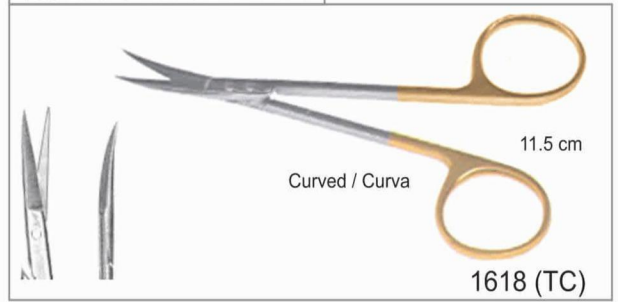

### GUBIAS

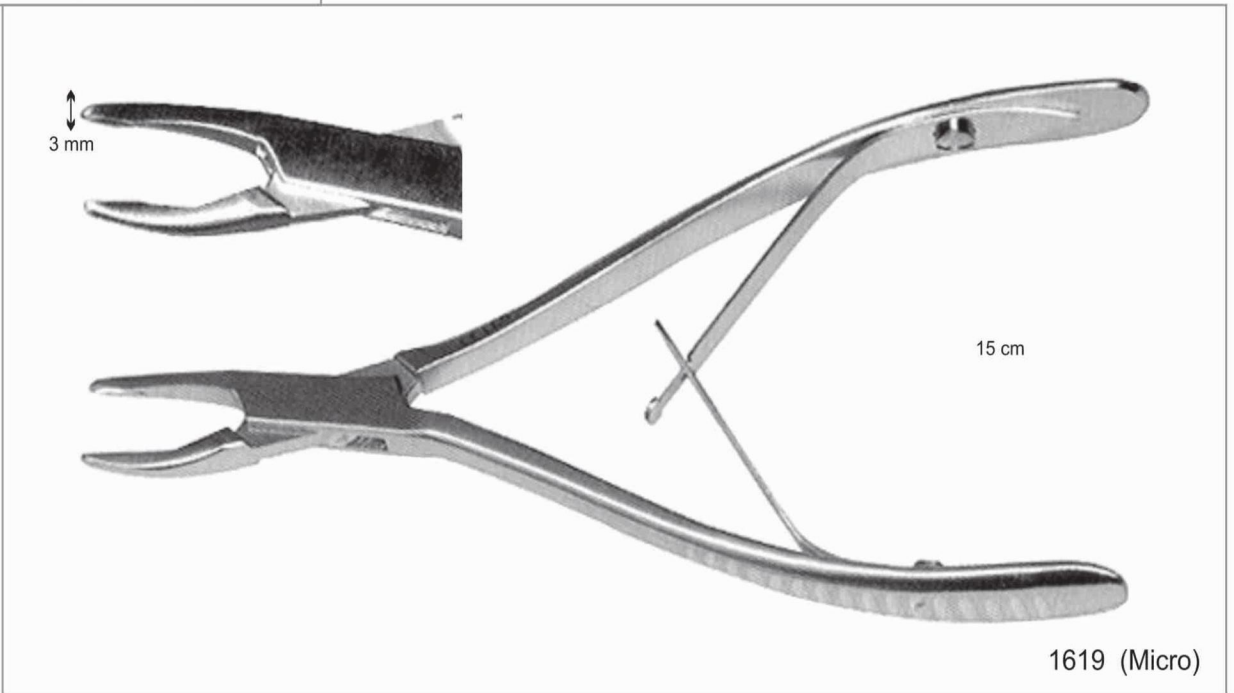

### GUBIAS

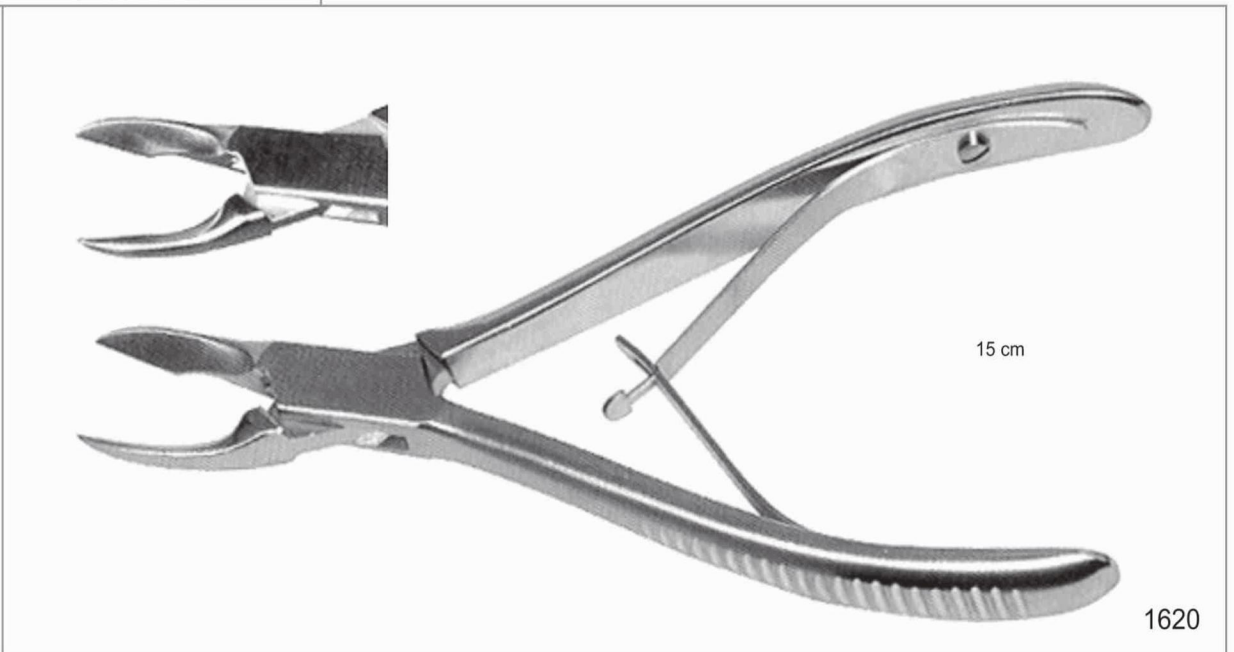

## Implant Instruments

### PORTA-AGUJAS CASTROVIEJO

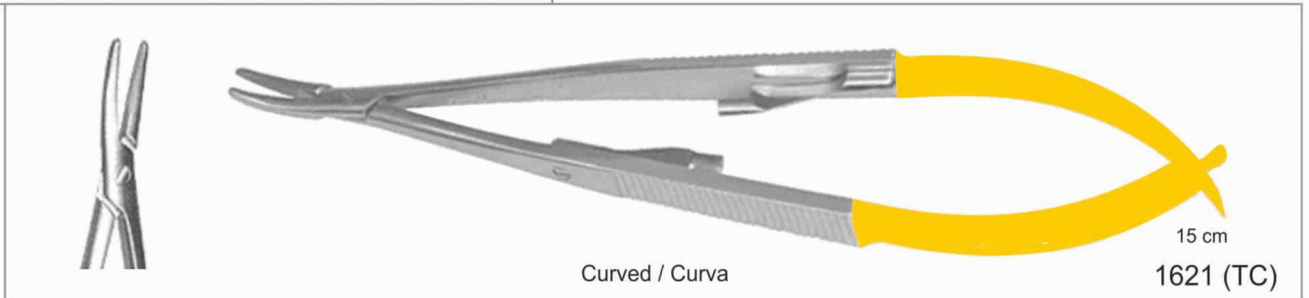

### CURETA MOLT

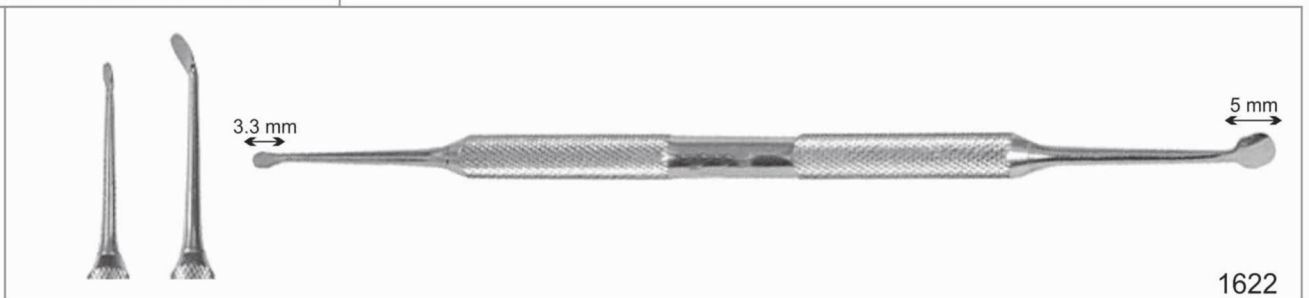

### MARTILLO

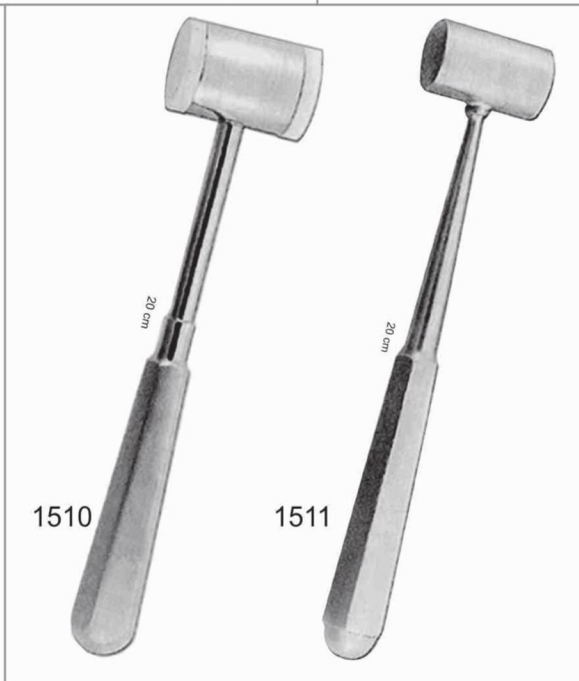

### BONE MILL MOLINILLO DE HUESO



### MOLINILLO DE HUESO

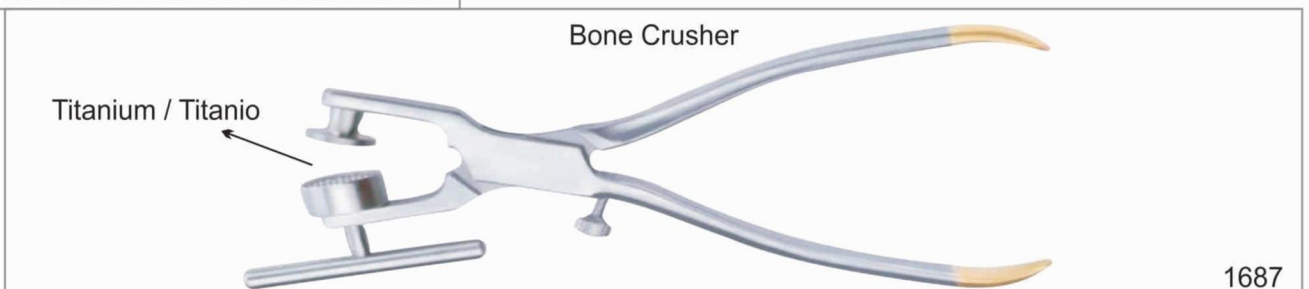



## Implant Instruments

### MANGO Y HOJAS DE BISTURI

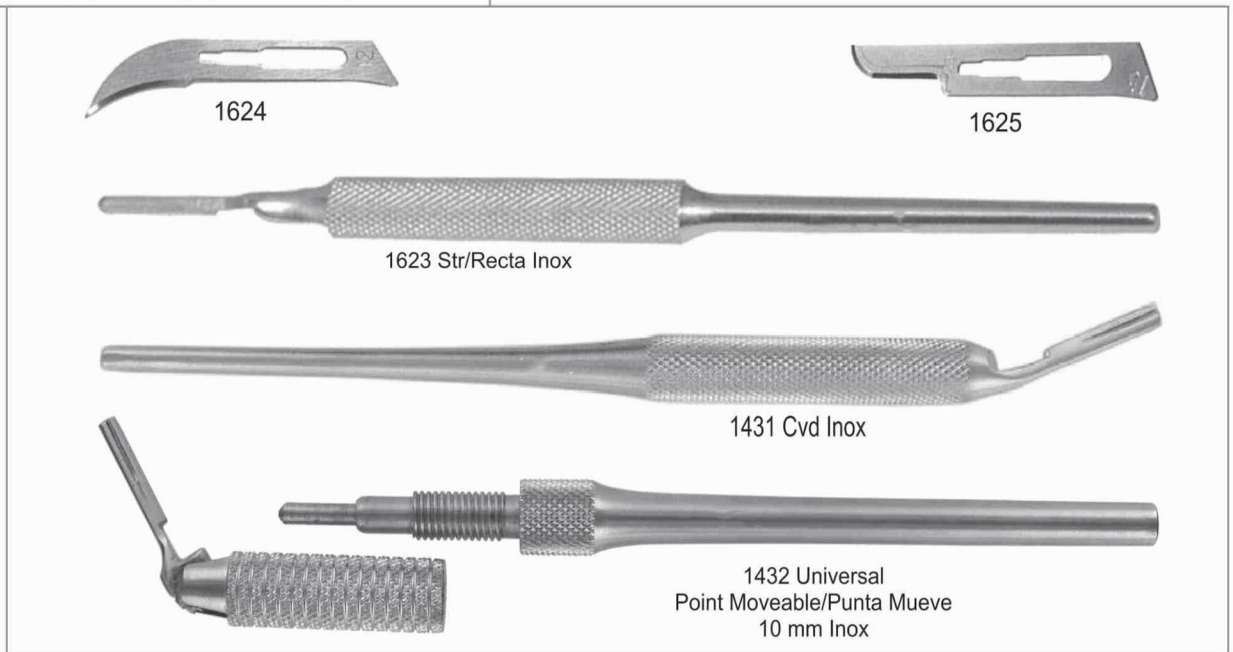

### MANGO Y MICROESPEJO

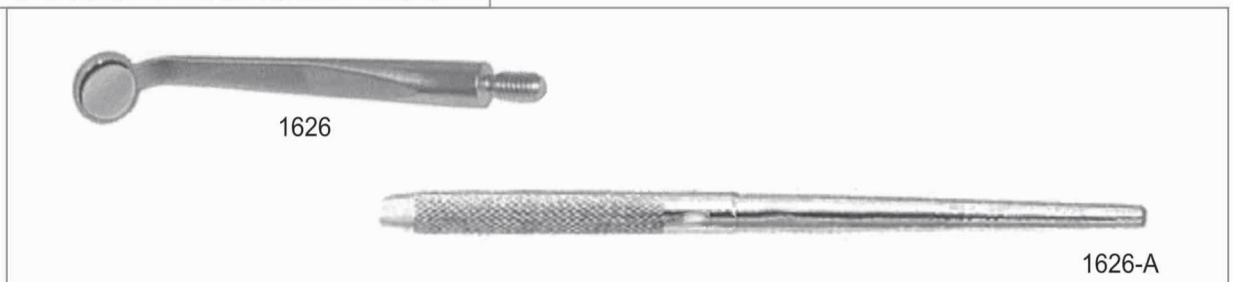

### ESPESIMETRO PARA HUESO

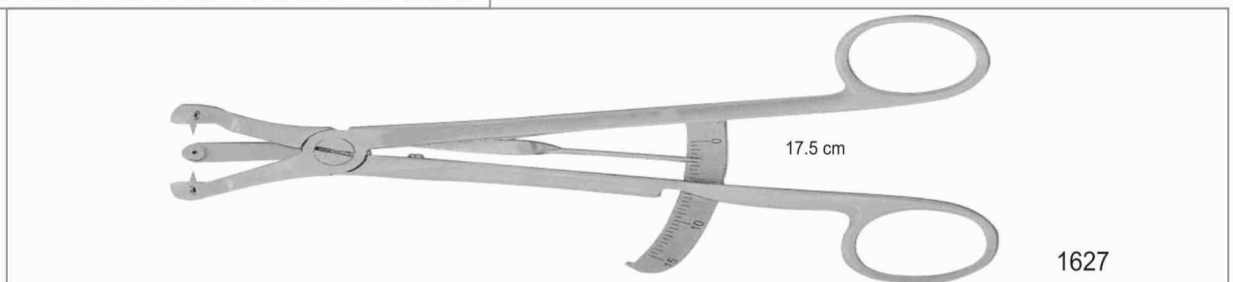

### LNYECTOR DE HUESO

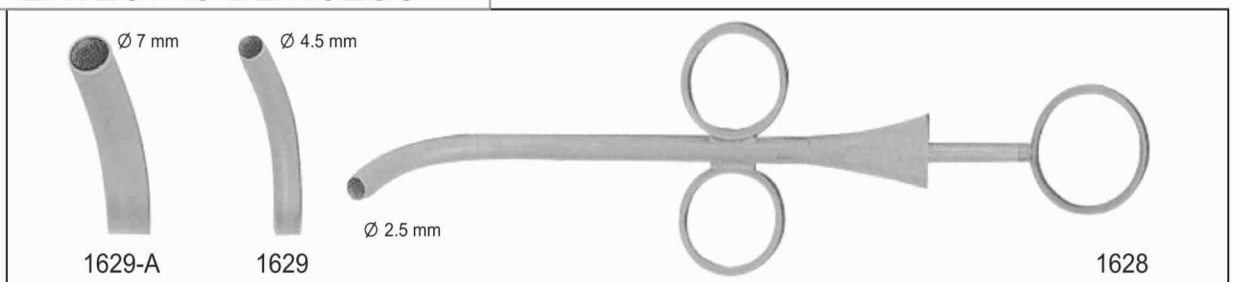

## Implant Instruments

SEPARADOR FARABEUF

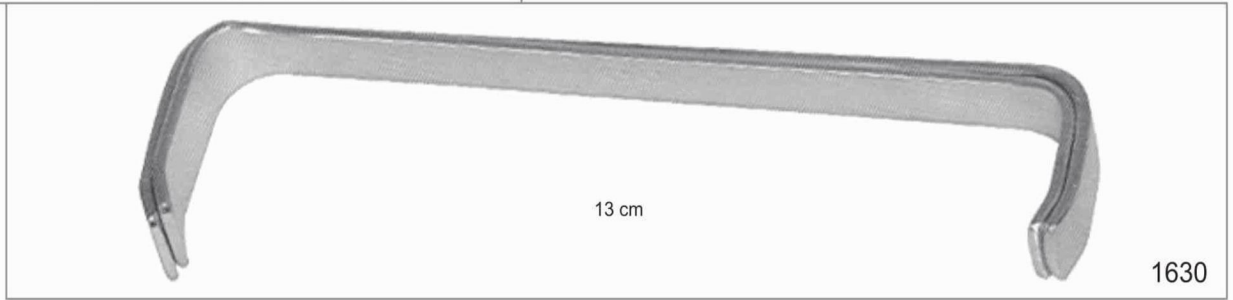

SEPARADOR DE TEJIDOS

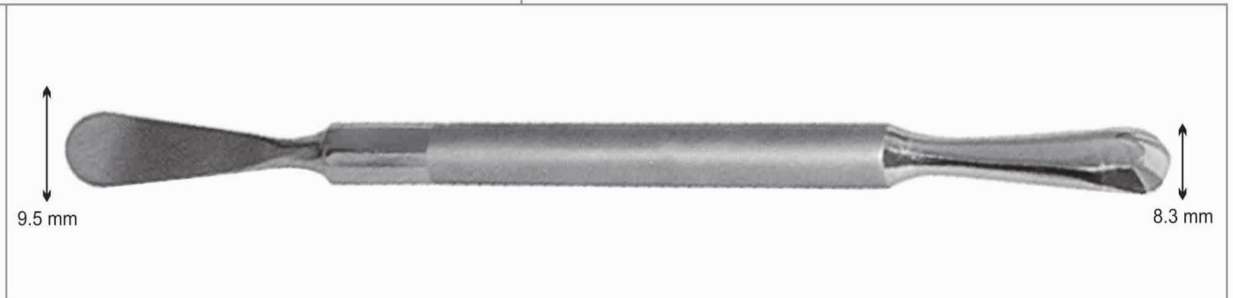

KIT DE ELEVACION DE SENO

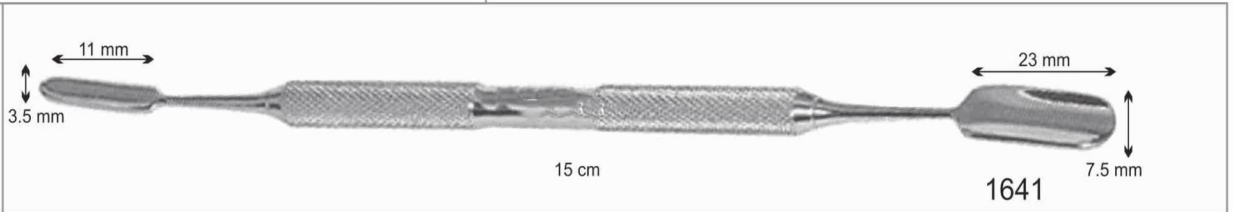

RASPADOR DE HUESO



RASPADOR DE HUESO

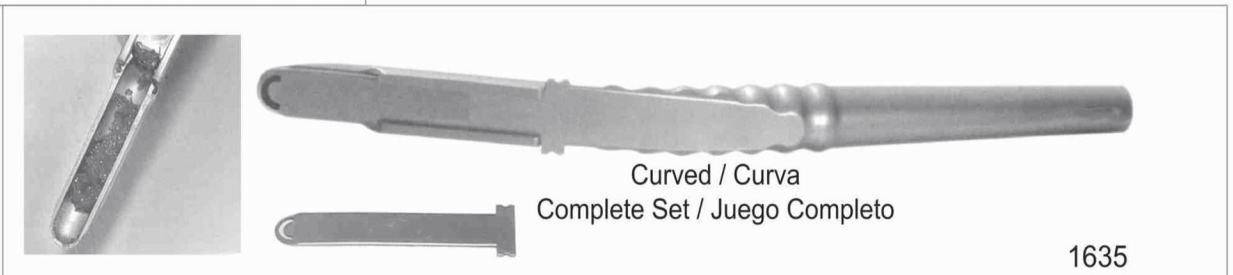

## Implant Instruments

### PINZA PARA MICROCIRUGIA

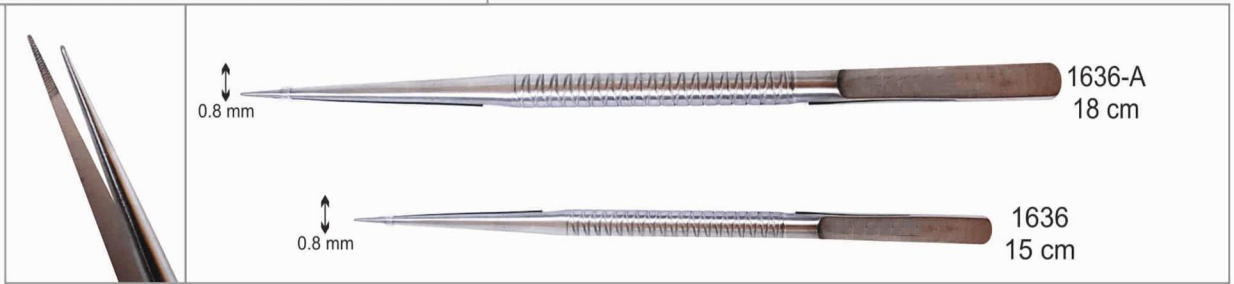

### PORTA-AGUJAS PARA MICROCIRUGIA

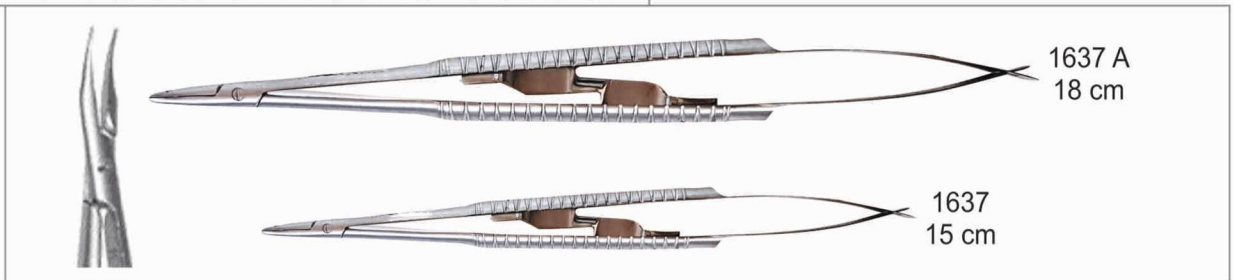

### KIT PARA MICROCIRUGIA

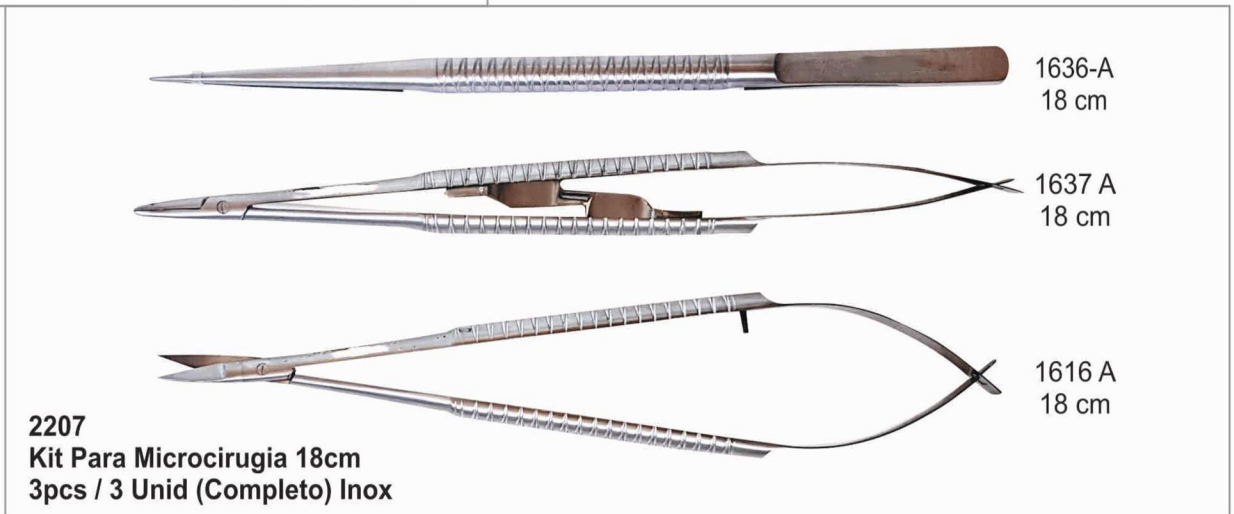

### COMPACTADORES DE HUESO

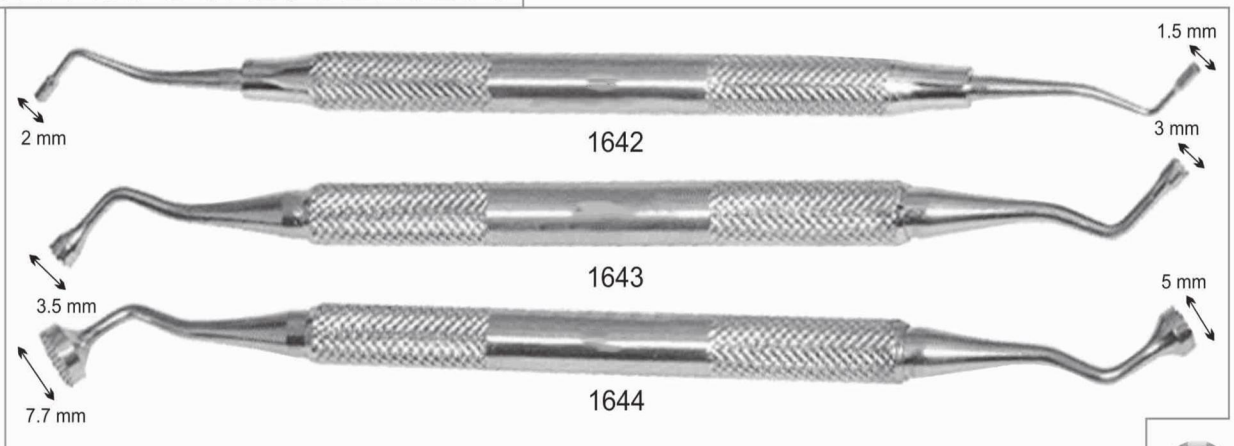



# Implant Instruments

## KIT DE ELEVACION DE SENO

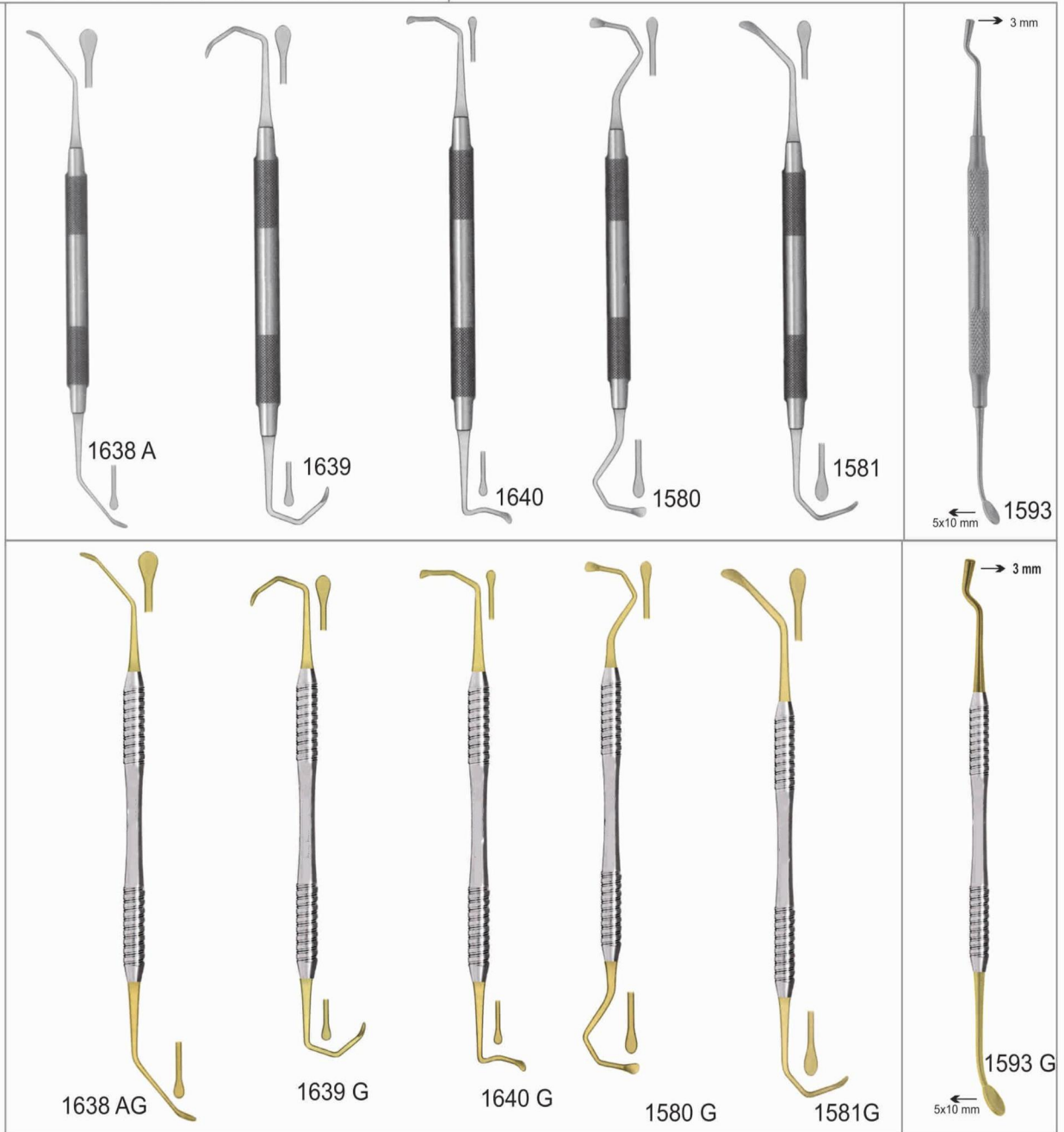

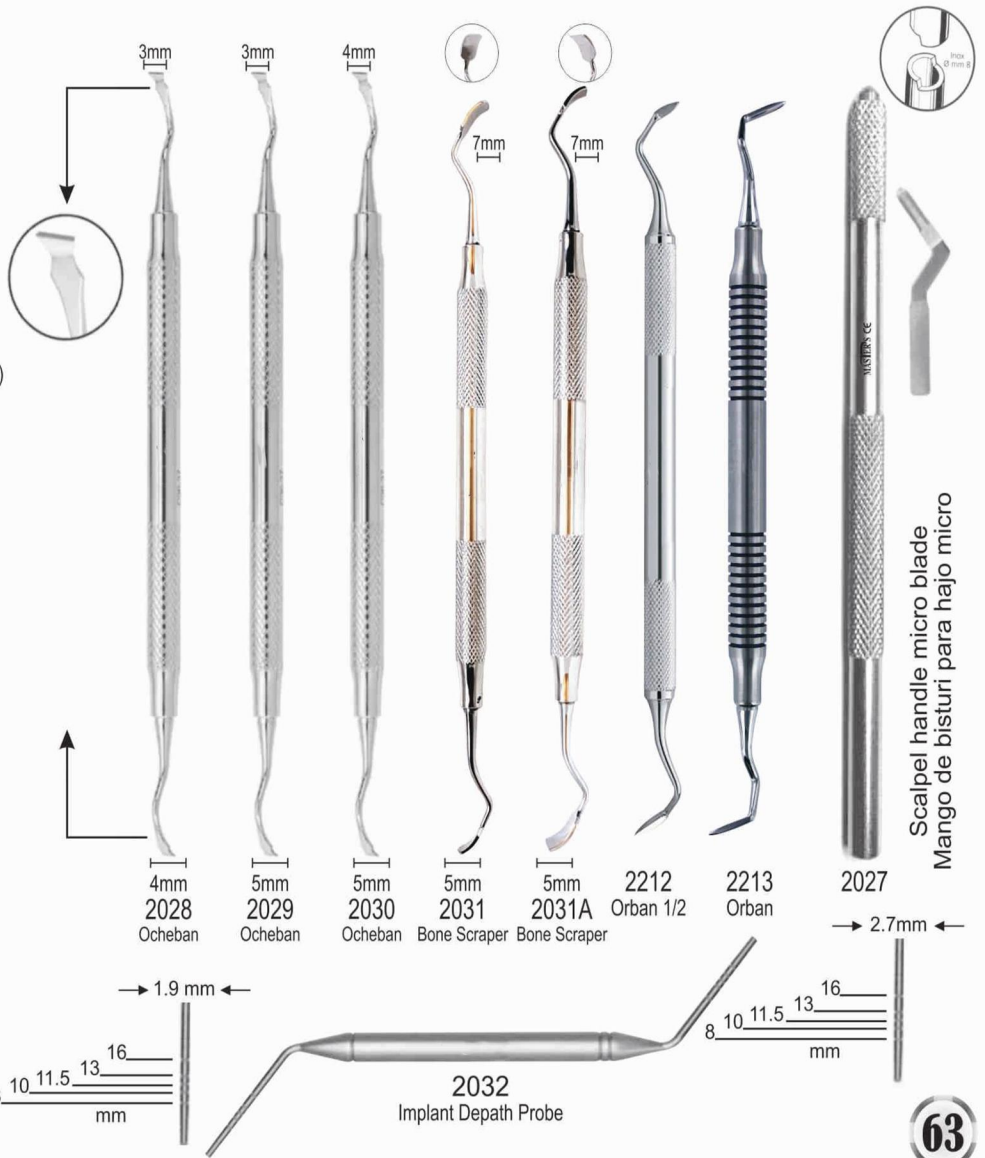
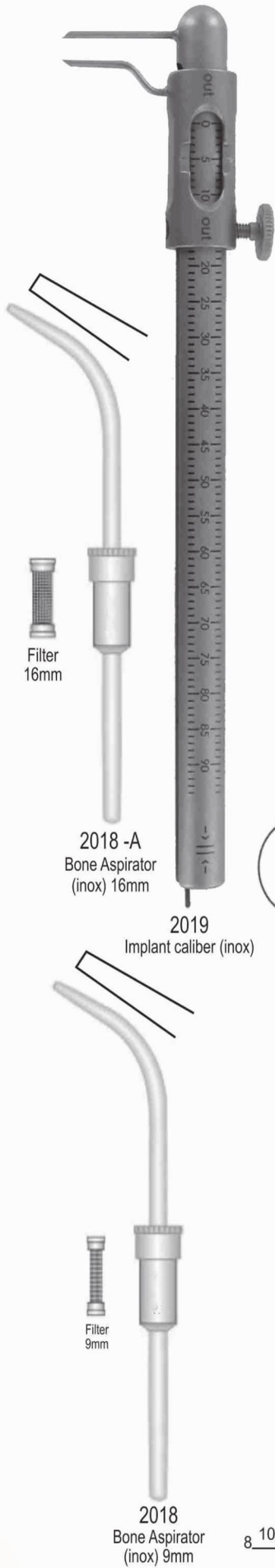

## Implant Instruments

### CINCELES

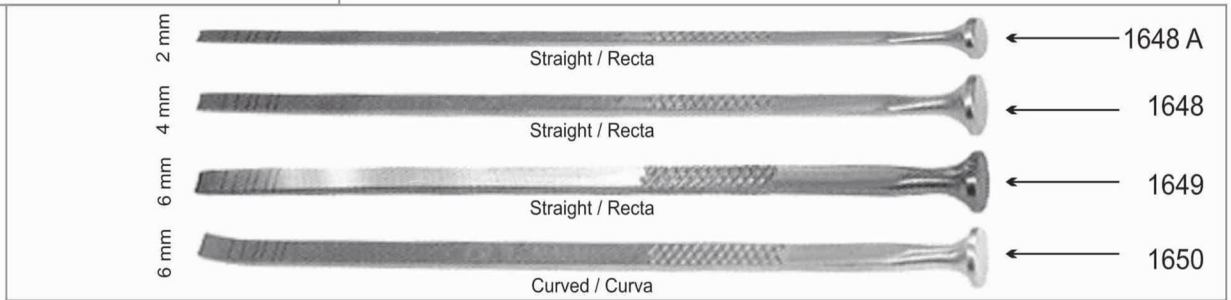

### KIT DE OBTENCION DE INJERTO DE TIBIA O CADERA

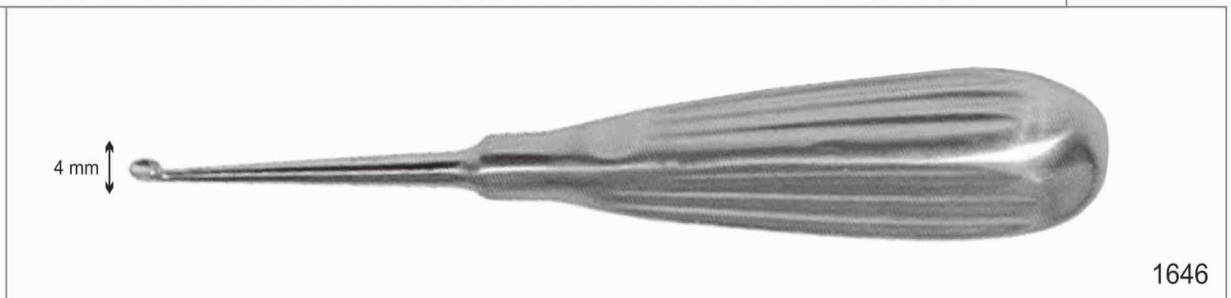

### KIT DE OBTENCION DE INJERTO DE TIBIA O CADERA

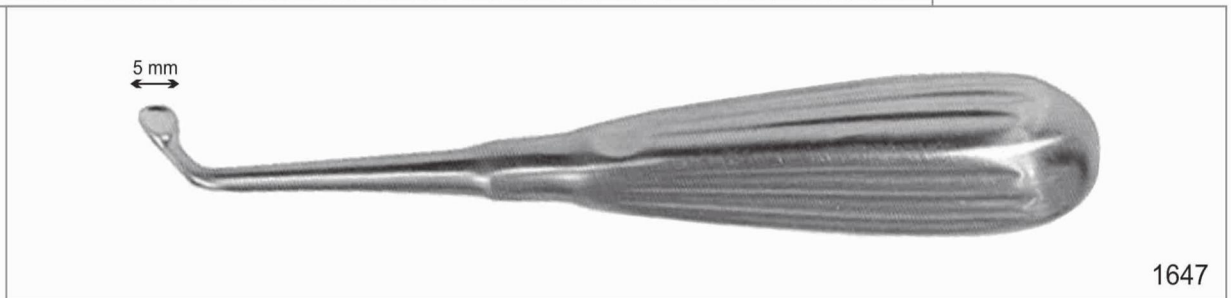

### PINZA PARA MEMBRANAS

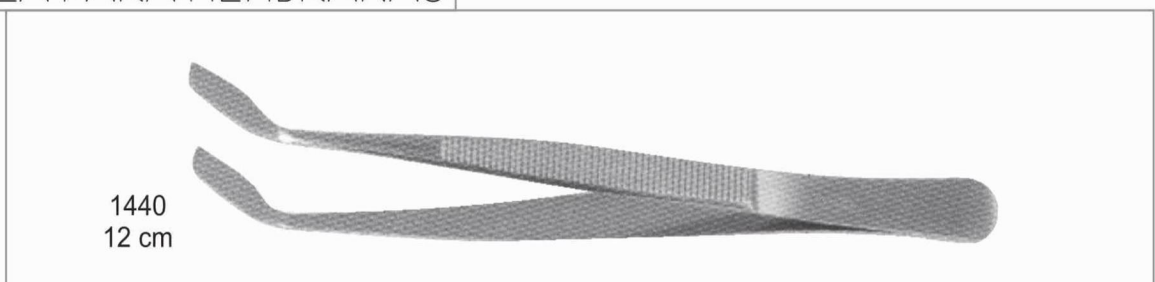

### VASO PARA HUESO (INOX)



Ø cm 3.5  
h. cm. 3.5  
1665



## Implant Instruments

IMPLANT TWEEZER

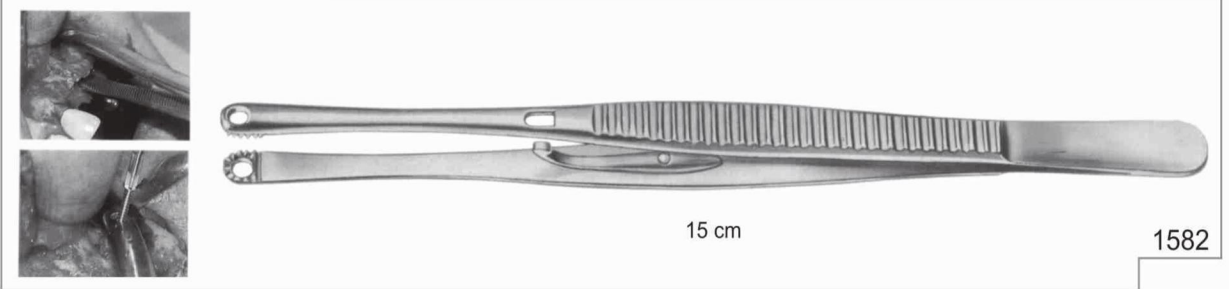

PINZA PARA INJERTOS EN BLOQUE

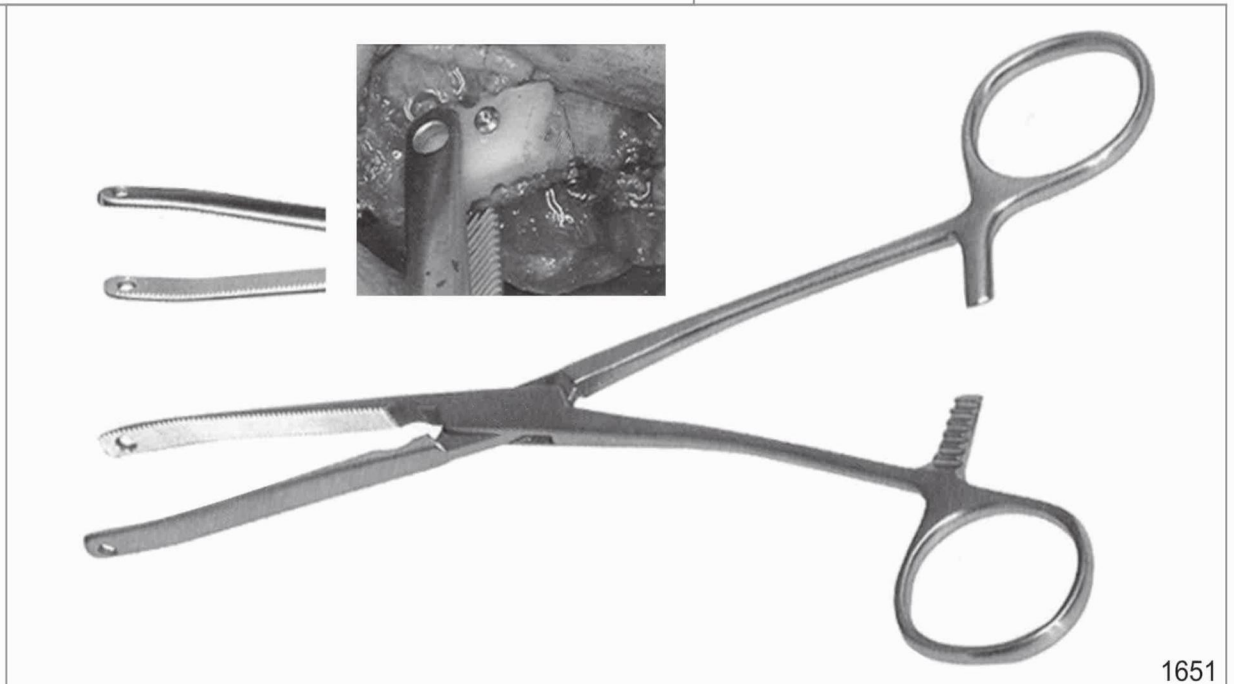

PINZA PARA INJERTOS EN BLOQUE

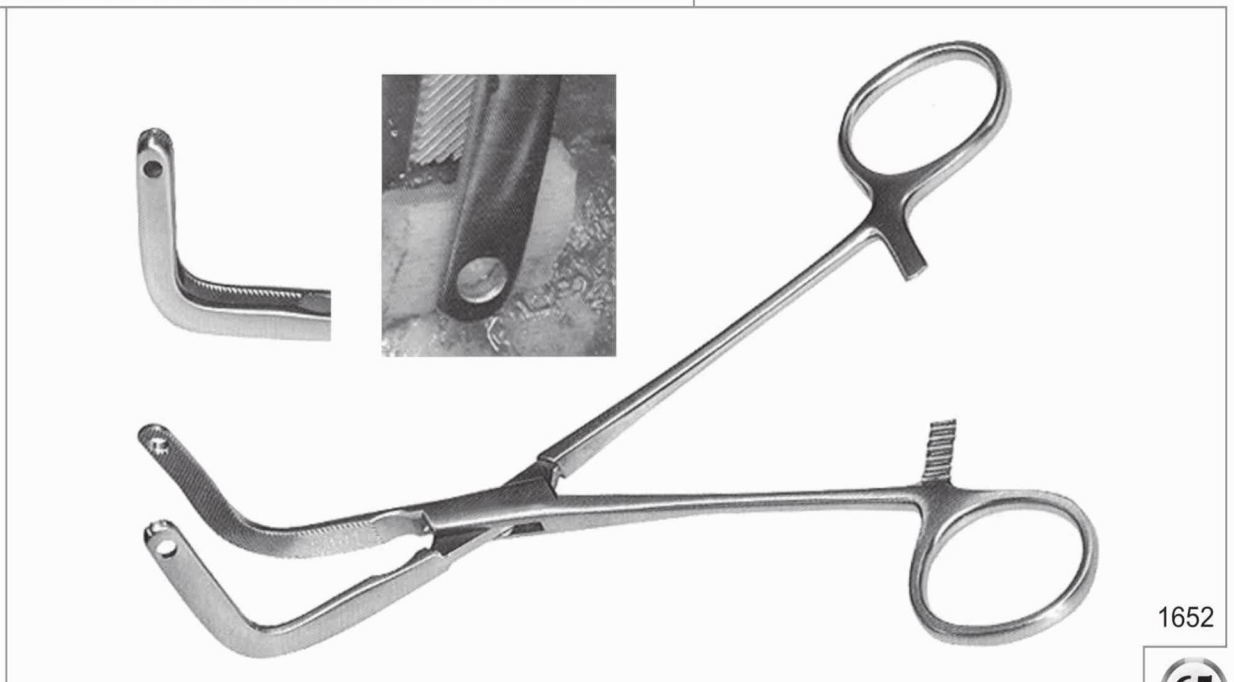

# Implant Instruments

## OSTEOTOMOS DILATABORES Y ESPANSORES

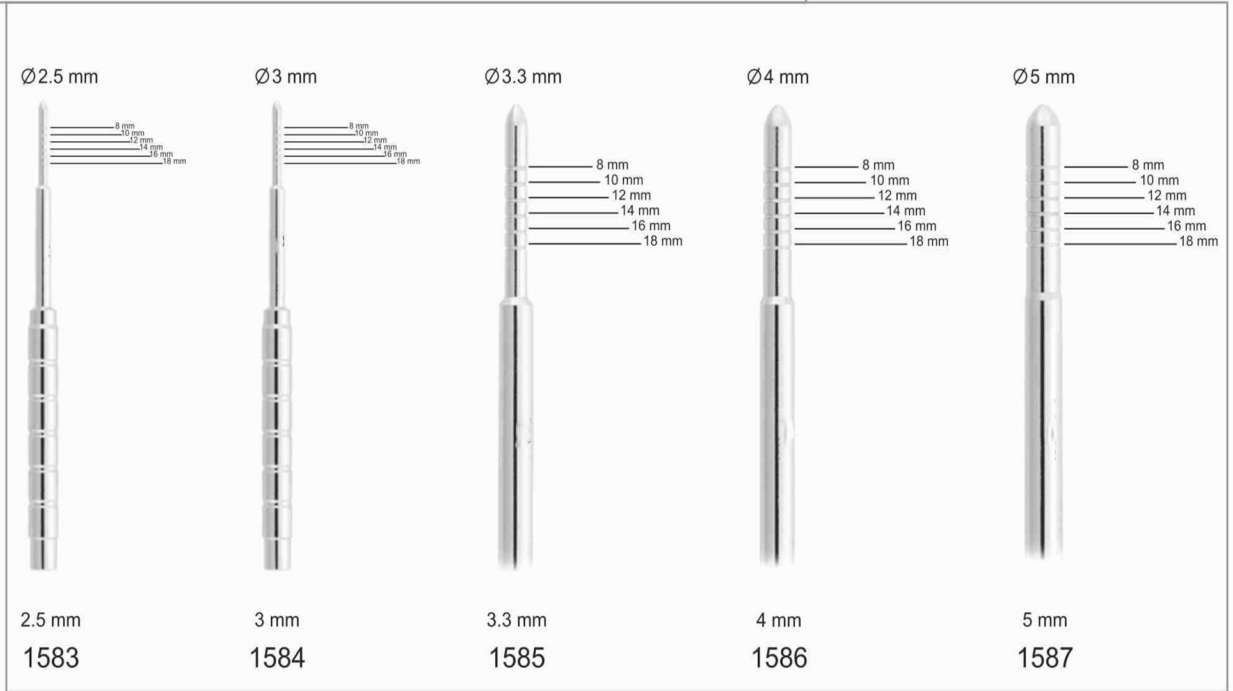

## OSTEOTOMOS DILATABORES Y ESPANSORES

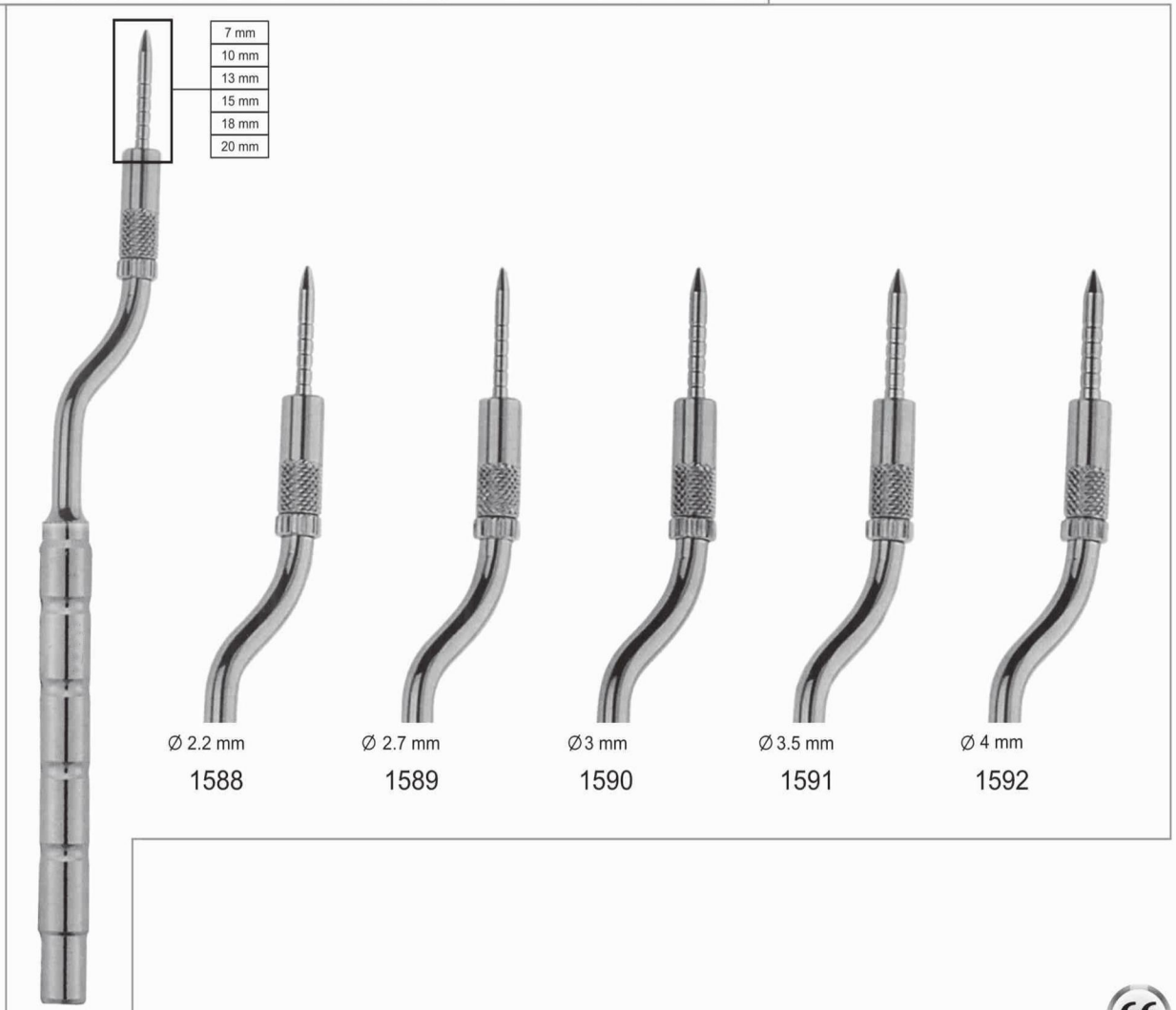

# Implant Instruments

## CONTENIDO

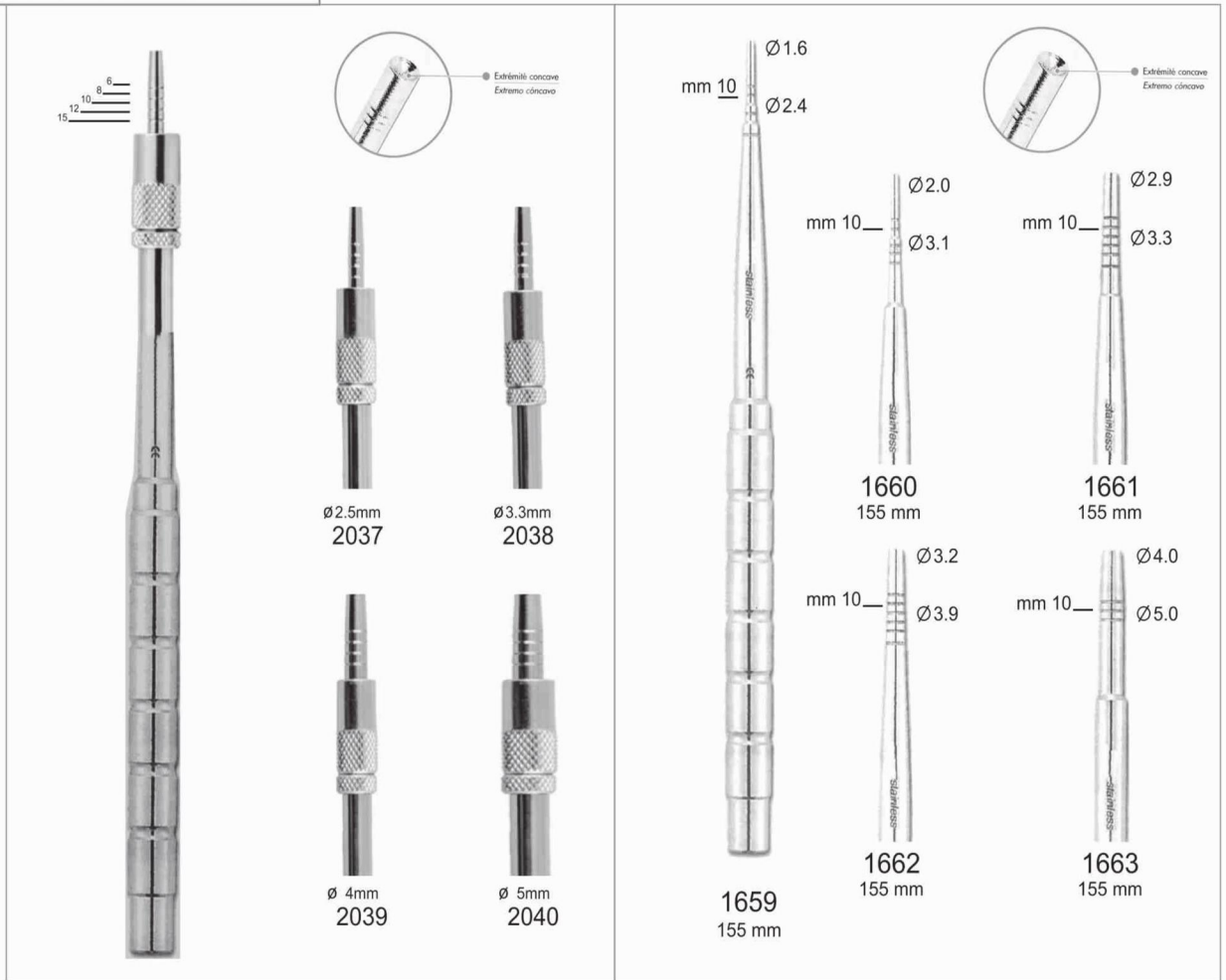



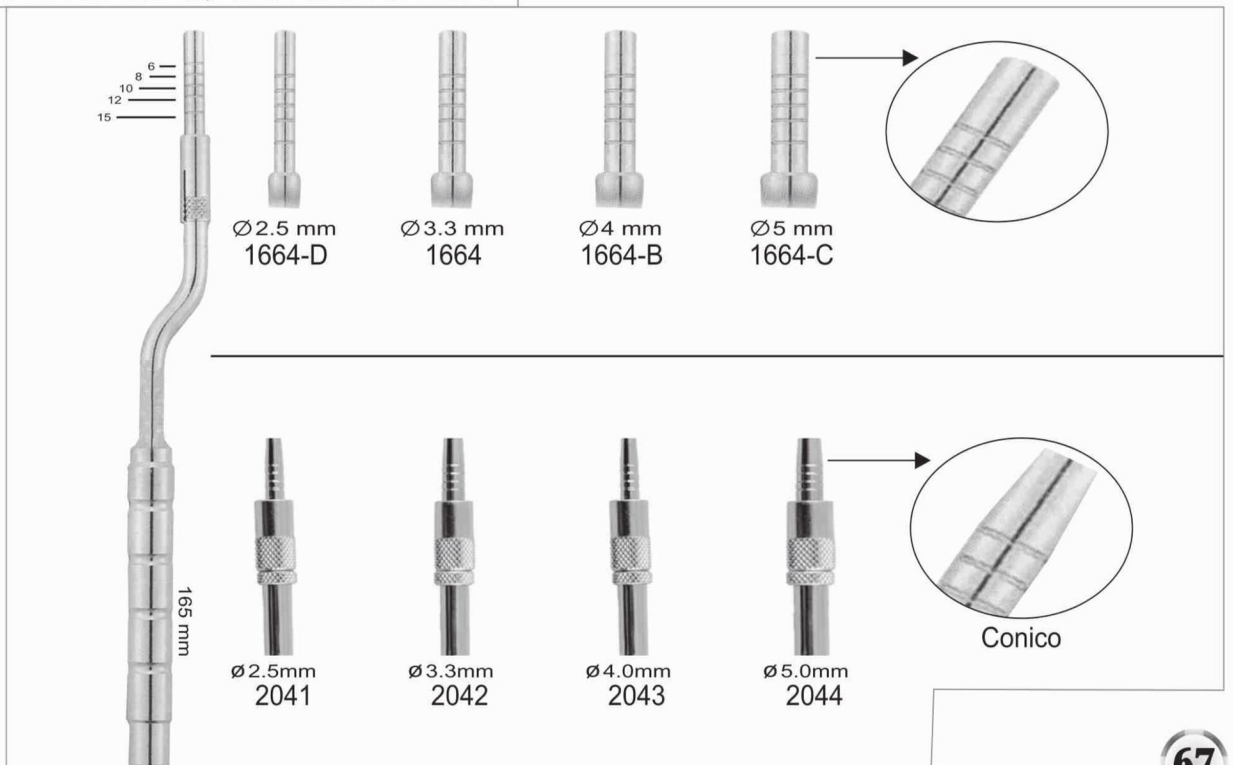

## CONTENIDO/OSTEOTOMOS





# Implant Instruments

## BISTURI CIRCULAR MANUAL

1433 5.1 mm (Inox)	
1434 4.5 mm (Inox)	
1435 4.1 mm (Inox)	
1436 3.5 mm (Inox)	
1437 3.0 mm (Inox)	

### Tissue Punch

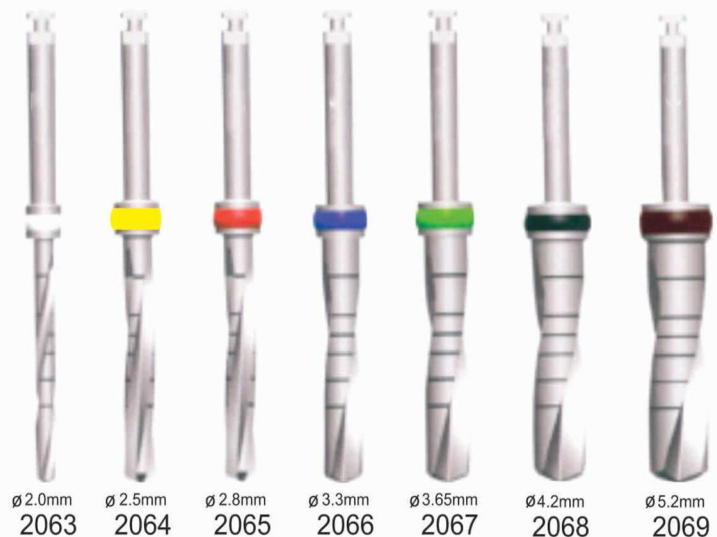
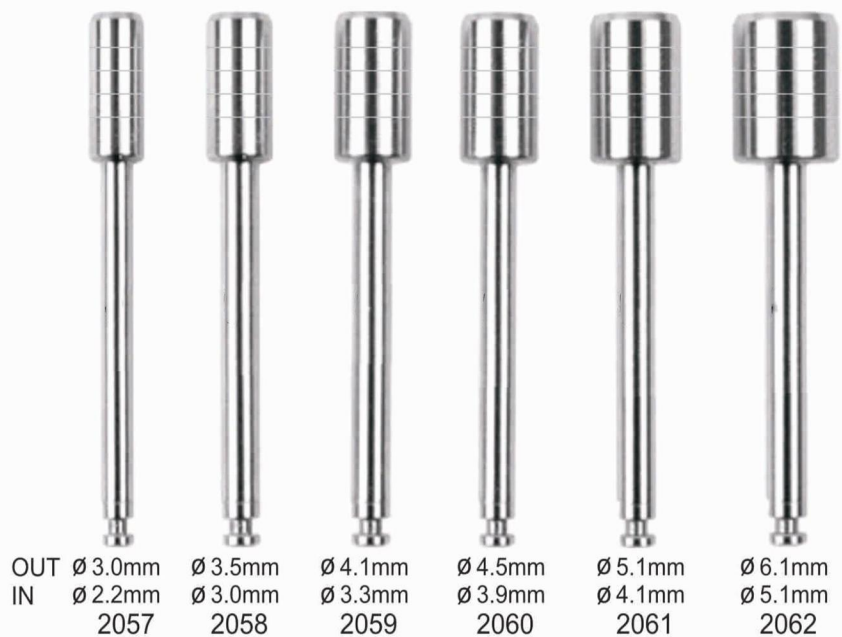

## Trephine Bur



OUT  $\varnothing$  3mm  
IN  $\varnothing$  2mm  
2045



OUT  $\varnothing$  4mm  
IN  $\varnothing$  3mm  
2046

$\varnothing$  5mm  
 $\varnothing$  4mm  
2047

$\varnothing$  6mm  
 $\varnothing$  5mm  
2048

$\varnothing$  7mm  
 $\varnothing$  6mm  
2049



## Bone Collector Trephine Bur

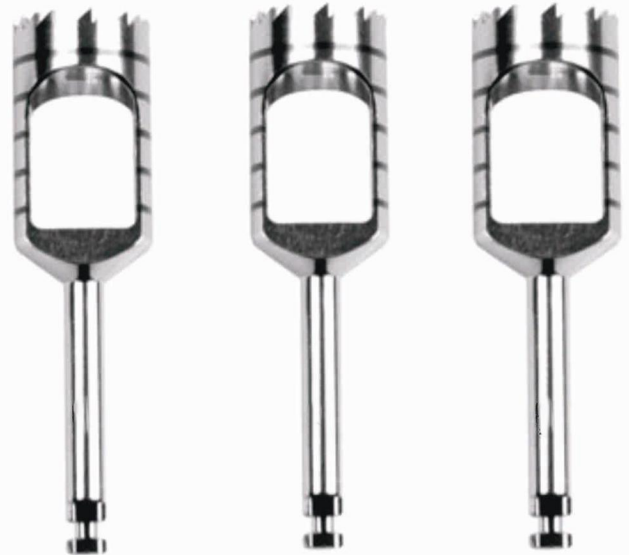

OUT  $\varnothing$  8mm  
IN  $\varnothing$  7mm  
2050

$\varnothing$  9mm  
 $\varnothing$  8mm  
2051

$\varnothing$  10mm  
 $\varnothing$  9mm  
2052



## Torque Wrench / Ratchet Wrench



2088  
Fix Point / Punta Fijo  
4.0mm / Octagonal



2088 A  
Ratchet Wrench / Square  
4.0 mm



2088 B  
Ratchet Wrench / Hexagonal  
6.35 mm



2078  
Torque Wrench/Square  
10/45-Ncm  
4.0mm



2087-2078 Set  
Movable Point/Punta Mueve  
Torque Wrench 6.35 mm  
Torque Wrench/Square 4.00mm  
10/45-Ncm

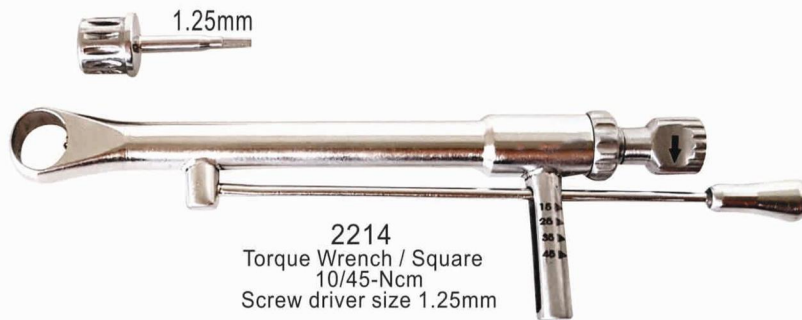

2214  
Torque Wrench / Square  
10/45-Ncm  
Screw driver size 1.25mm

## 5 bone expander diameters



∅ 2.5mm  
2070



∅ 3.0mm  
2071



∅ 3.5mm  
2072



∅ 4.0mm  
2073



∅ 4.5mm  
2074

4 score lines per  
expander

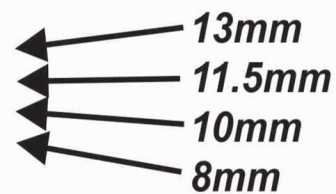

13mm

11.5mm

10mm

8mm



## Lance Pilot Drills 1.2 and 1.5 mm. Diameter



### Drill Extender

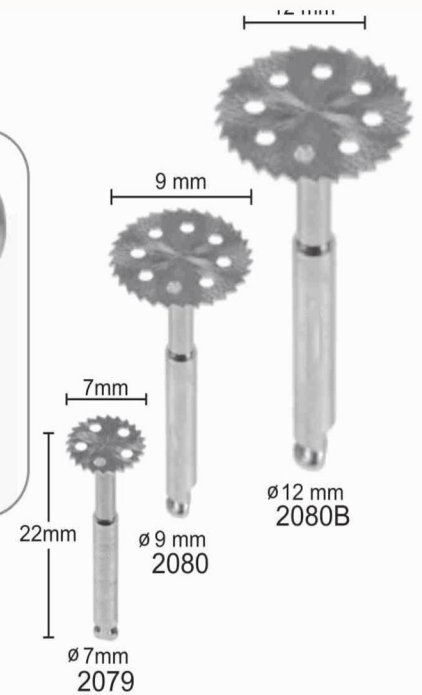

### Drill Kit with Stoper



2215

Drill kit Complete (Conical / Conico)  
30-pcs / 30-Unid

### 1.25 mm. Long/Regular/Short



### Hand Hex Driver 1.25mm

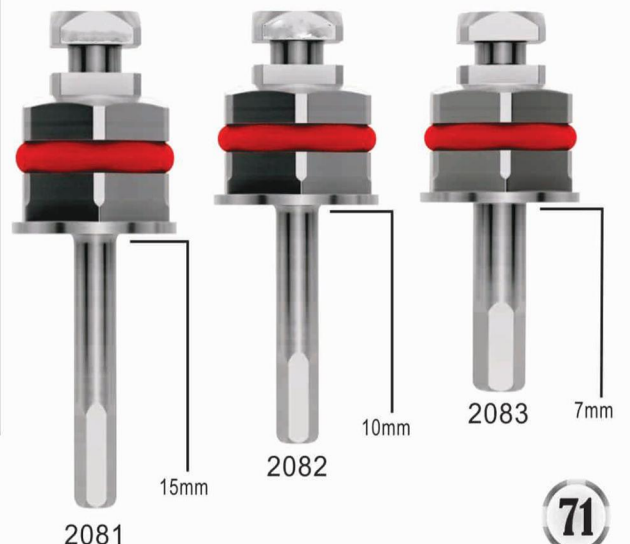

## Bone Expander Kit



5 bone expander diameters



4 score lines per expander

13mm  
11.5mm  
10mm  
8mm

2.5 3.0 3.5 4.0 4.5mm

Ratchet Wrench



Pilot Drill

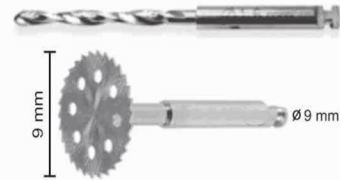

Latch Style Hand Piece Adaptor

2089

Bone Expander Kit (Complete)

## Bone Compression Kit Sinus Lifting



2090

Bone Compression Kit (Complete)



## Bone Collector Kit



2091  
Bone Crushing  
Triturador de Hueso



## Bone Trimmer Kit



2092  
Bone Trimmer

## Surgical Long Drill Kit



2093  
Surgical Drill Kit





GERMAN STEEL

666 691 426 

kauradent@gmail.com 

Transform  
your smile.



CE